

FLOOR PLAN LAYOUT

TOWER A - SOBHA ORBIS

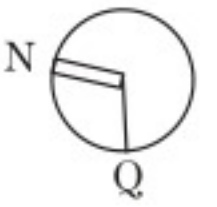

VILLA COMMUNITY, GOLF COURSE

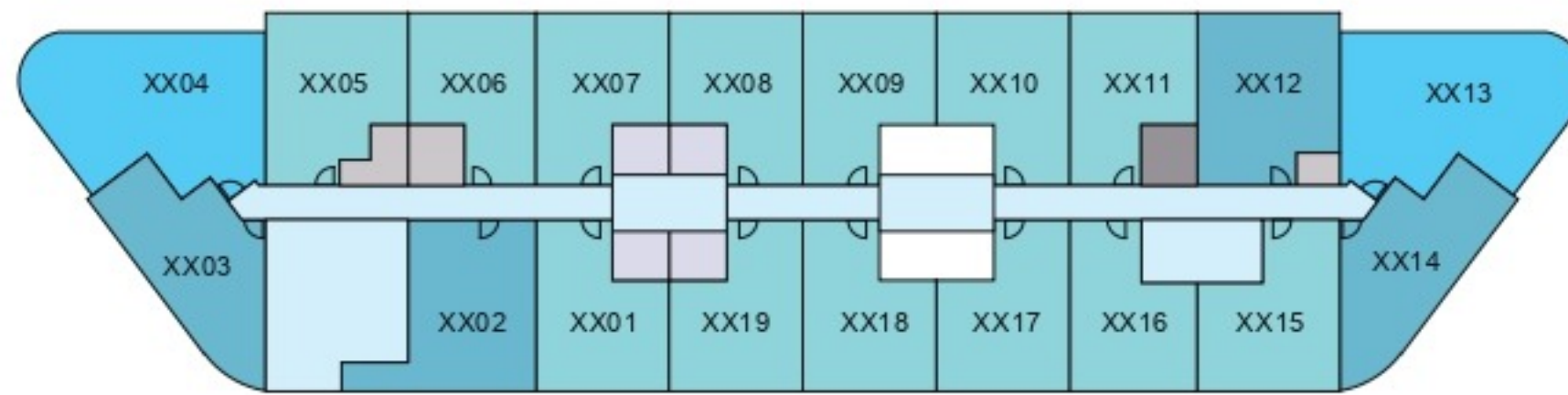

COMMUNITY AND CITY VIEWS

LEVEL - 03 - 21



VILLA COMMUNITY, GOLF COURSE

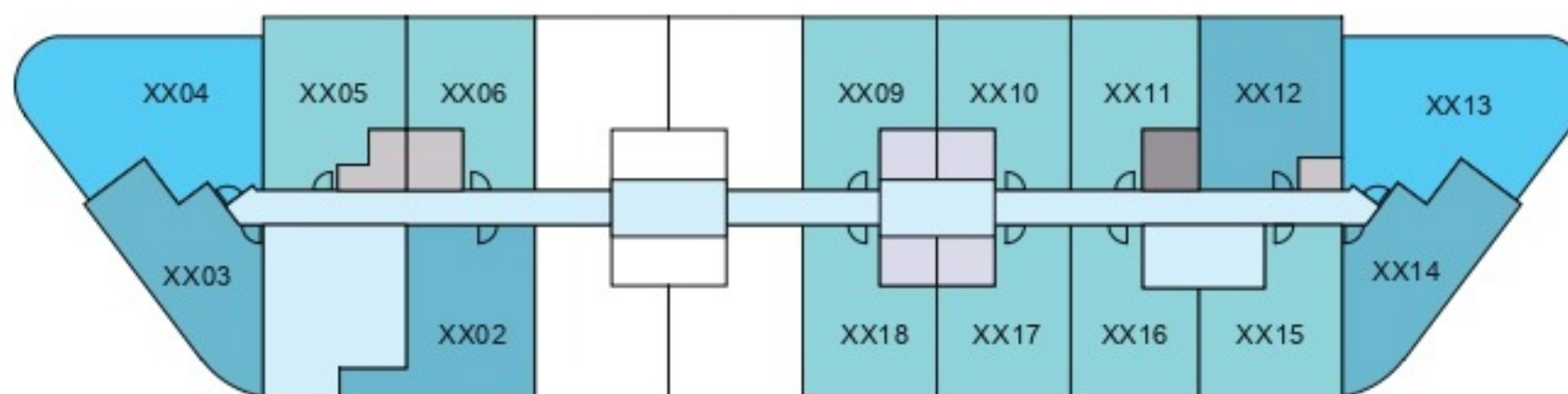

COMMUNITY AND CITY VIEWS

LEVEL - 22 - 32



VILLA COMMUNITY, GOLF COURSE

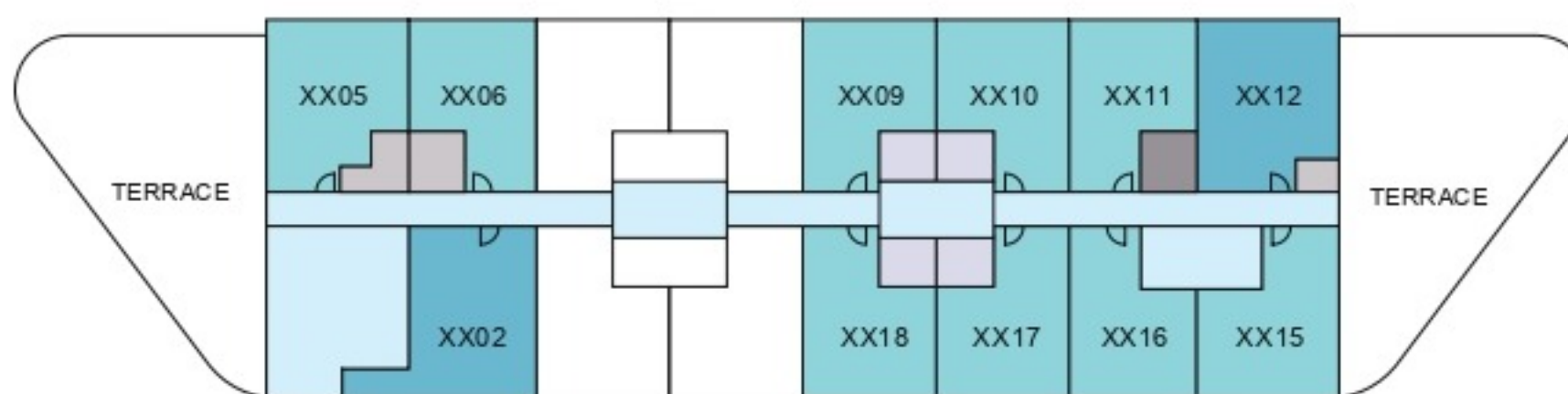

COMMUNITY AND CITY VIEWS

LEVEL - 33, 34

- 1 BED UNIT
- 2 BED UNIT
- CIRCULATION
- LIFTS
- 1.5 BED UNIT
- SERVICES
- GARBAGE ROOM

Disclaimer: 1. All dimensions are in metric, measured to wall finishes. 2. All materials, dimensions & drawings are approximate. 3. Information is subject to change without notice, at developer's absolute discretion. 4. Actual area may vary from the stated area. 5. Drawing are not to scale. 6. All images used are for illustrative purpose only and do not represent the actual size, features, specifications, fittings and furnishings. 7. The developer reserves the right to make revisions/ alterations, at its absolute discretion, without any liability whatsoever.

1 BEDROOM APARTMENT

TYPE A (with balcony)

TOTAL SALEABLE AREA

SUITE RANGE = 490.94 SQ.FT. - 493.09 SQ.FT.

BALCONY = 54.14 SQ.FT.

TOTAL RANGE = 545.08 SQ.FT. - 547.23 SQ.FT.

 UNIT

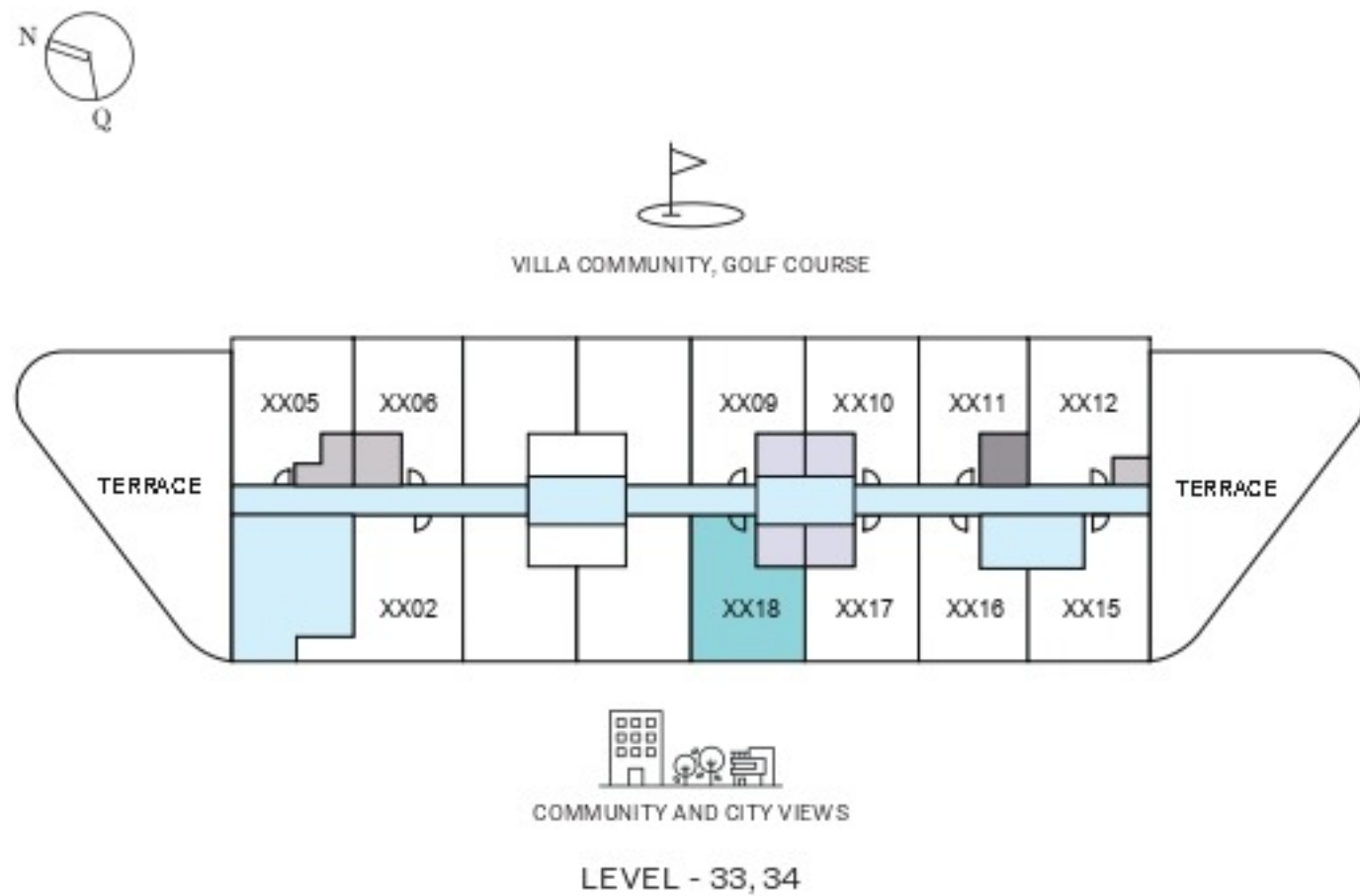
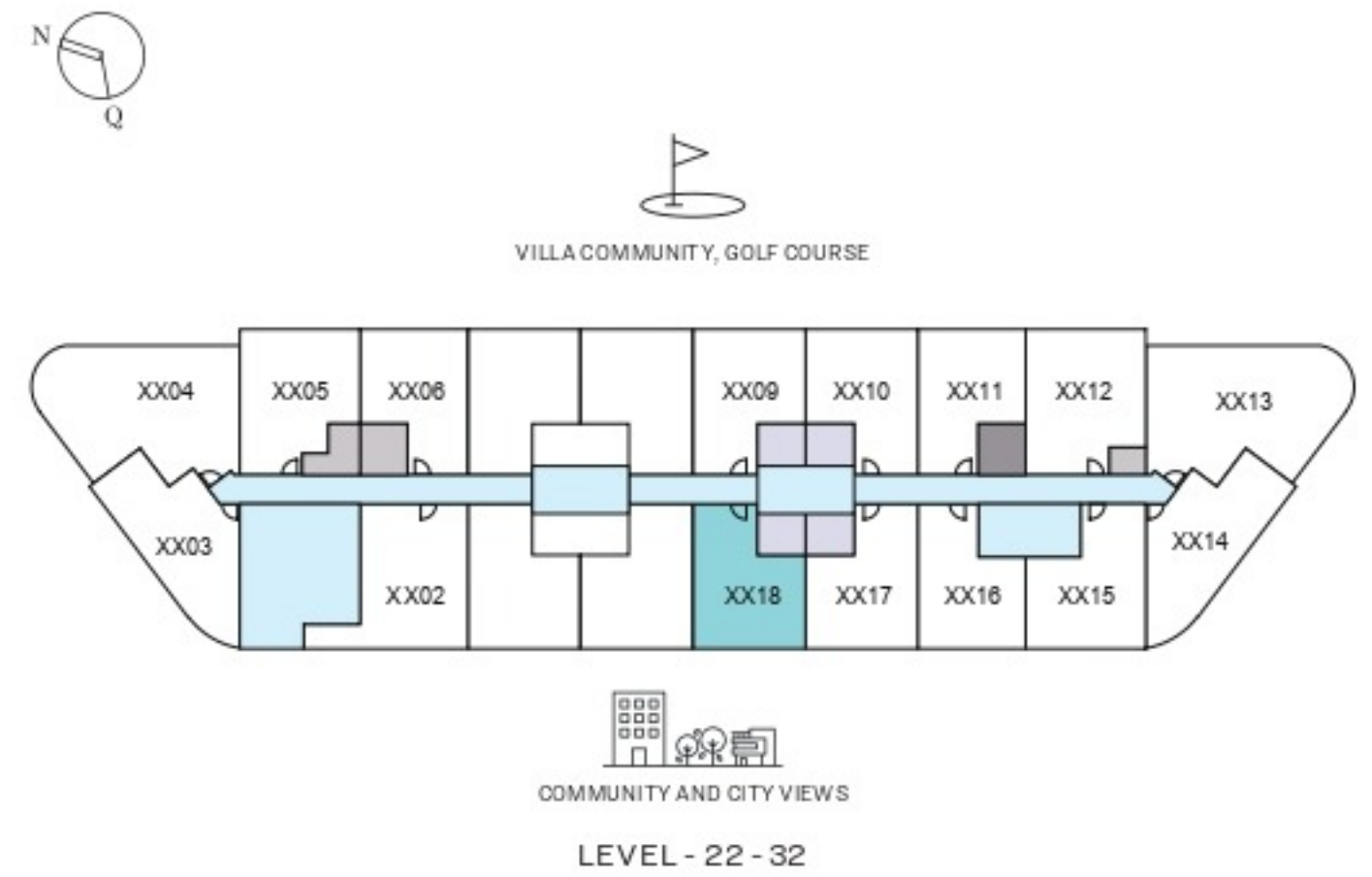
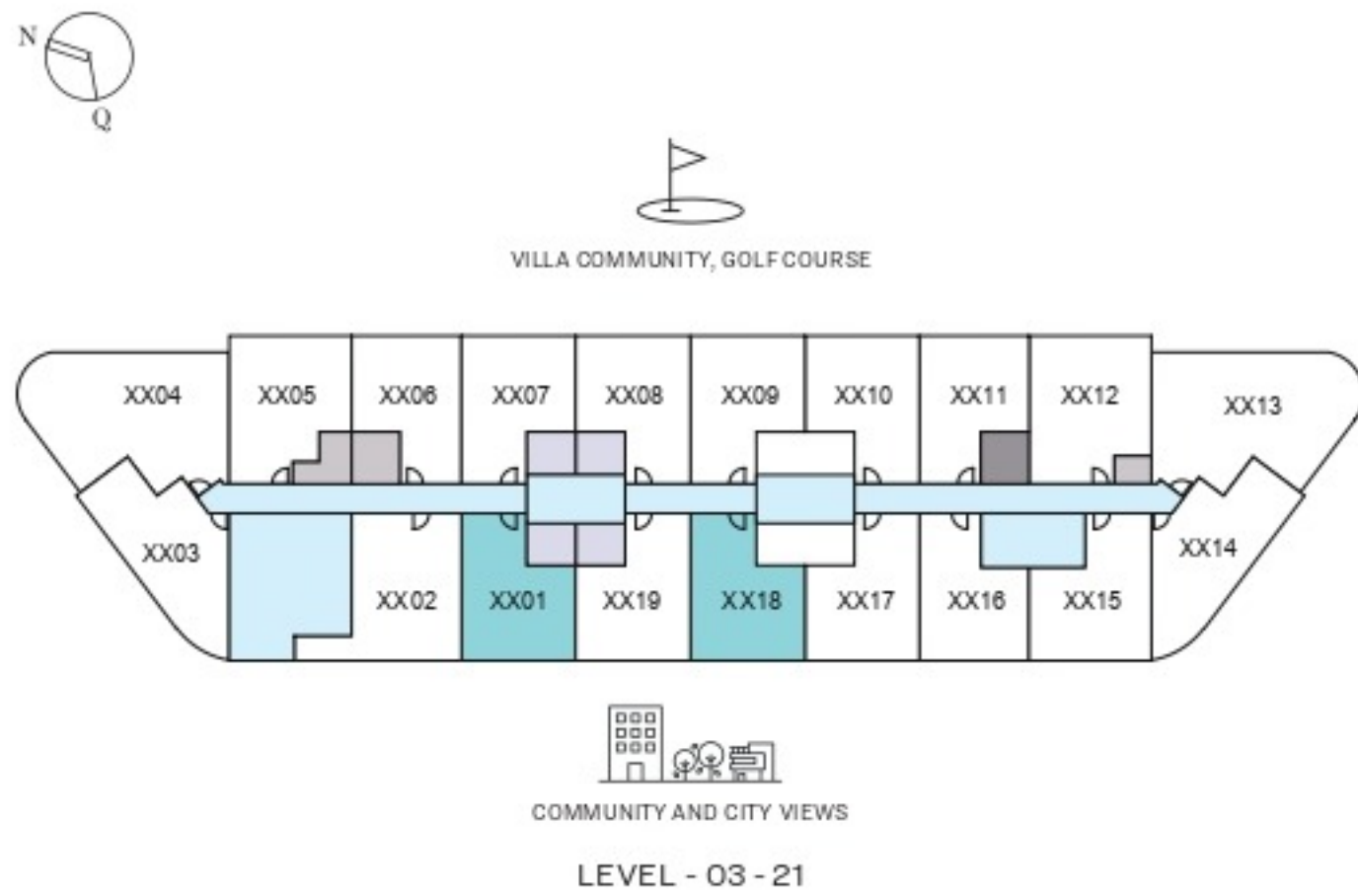

List of unit numbers with this unit plan:

VIEWS

Amenities

A318, A418, A518, A618, A718, A818, A918, A1018, A1118, A1218, A1318, A1418, A1518, A1618, A1718, A1818, A1918, A2018

Community, City View

A501, A601, A701, A801, A901, A1001, A1101, A1201, A1301, A1401, A1501, A1601, A1701, A1801, A2118, A2218, A2318, A2418, A2518, A2618, A2718, A2818, A2918, A3018, A3118, A3218, A3318, A3418

Street View

A301, A401

Disclaimer: 1. All dimensions are in metric, measured to wall finishes. 2. All materials, dimensions & drawings are approximate. 3. Information is subject to change without notice, at developer's absolute discretion. 4. Actual area may vary from the stated area. 5. Drawing are not to scale. 6. All images used are for illustrative purpose only and do not represent the actual size, features, specifications, fittings and furnishings. 7. The developer reserves the right to make revisions/ alterations, at its absolute discretion, without any liability whatsoever.

1 BEDROOM APARTMENT

TYPE A (with balcony)

TOTAL SALEABLE AREA

SUITE RANGE = 490.94 SQ.FT. - 493.09 SQ.FT.

BALCONY = 54.14 SQ.FT.

TOTAL RANGE = 545.08 SQ.FT. - 547.23 SQ.FT.

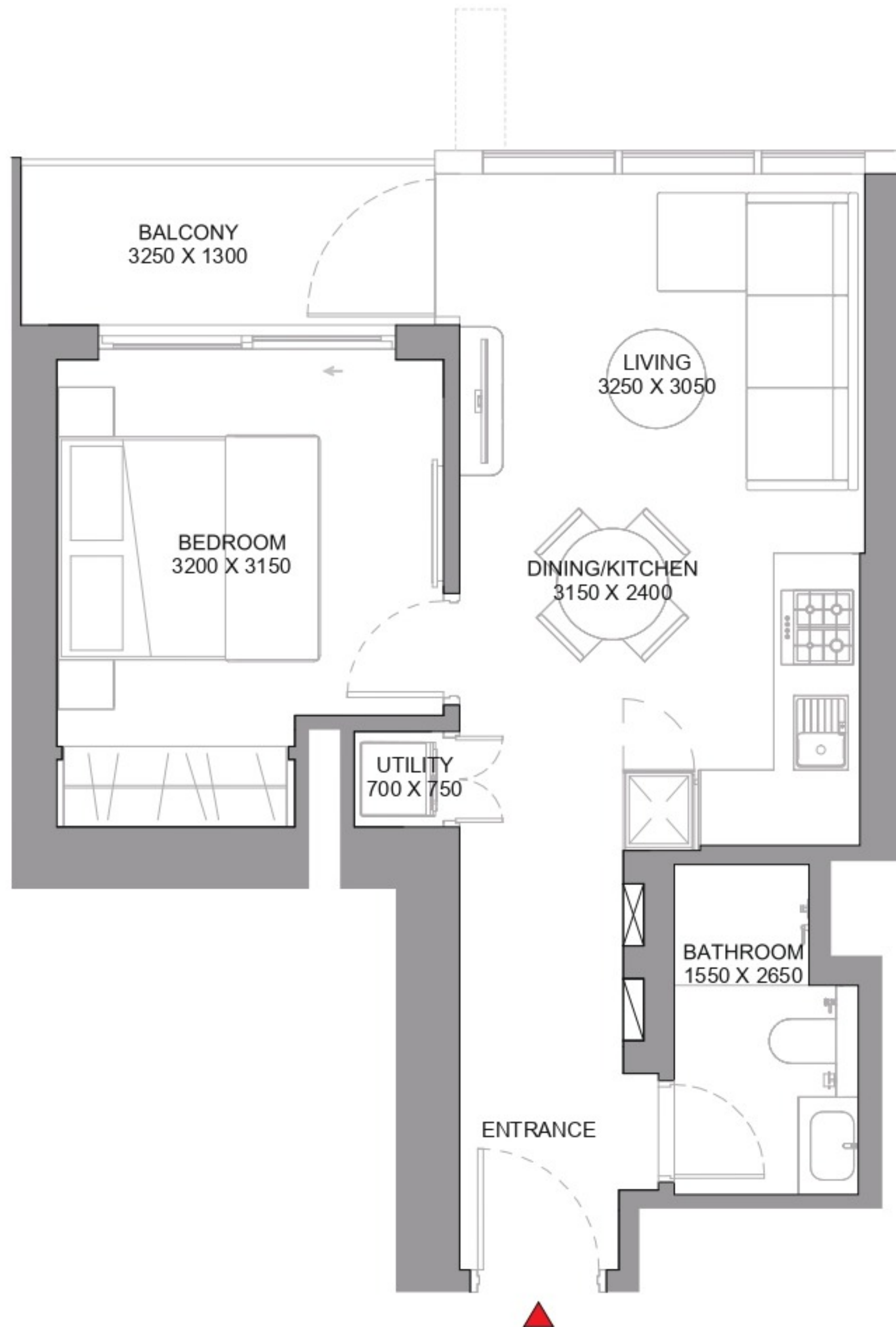

List of unit numbers with this unit plan:

VIEWS

Amenities

A318, A418, A518, A618, A718, A818, A918, A1018, A1118, A1218, A1318, A1418, A1518, A1618, A1718, A1818, A1918, A2018

Community, City View

A501, A601, A701, A801, A901, A1001, A1101, A1201, A1301, A1401, A1501, A1601, A1701, A1801, A2118, A2218, A2318, A2418, A2518, A2618, A2718, A2818, A2918, A3018, A3118, A3218, A3318, A3418

Street View

A301, A401

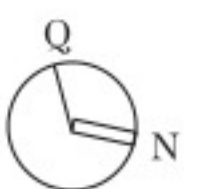

Disclaimer: 1. All dimensions are in metric, measured to wall finishes. 2. All materials, dimensions & drawings are approximate. 3. Information is subject to change without notice, at developer's absolute discretion. 4. Actual area may vary from the stated area. 5. Drawing are not to scale. 6. All images used are for illustrative purpose only and do not represent the actual size, features, specifications, fittings and furnishings. 7. The developer reserves the right to make revisions/ alterations, at its absolute discretion, without any liability whatsoever.

1 BEDROOM APARTMENT

TYPE A (with balcony) VARIANT 1

TOTAL SALEABLE AREA

SUITE RANGE = 486.96 SQ.FT. - 490.40 SQ.FT.

BALCONY = 56.51 SQ.FT.

TOTAL RANGE = 543.47 SQ.FT. - 546.91 SQ.FT.

 UNIT

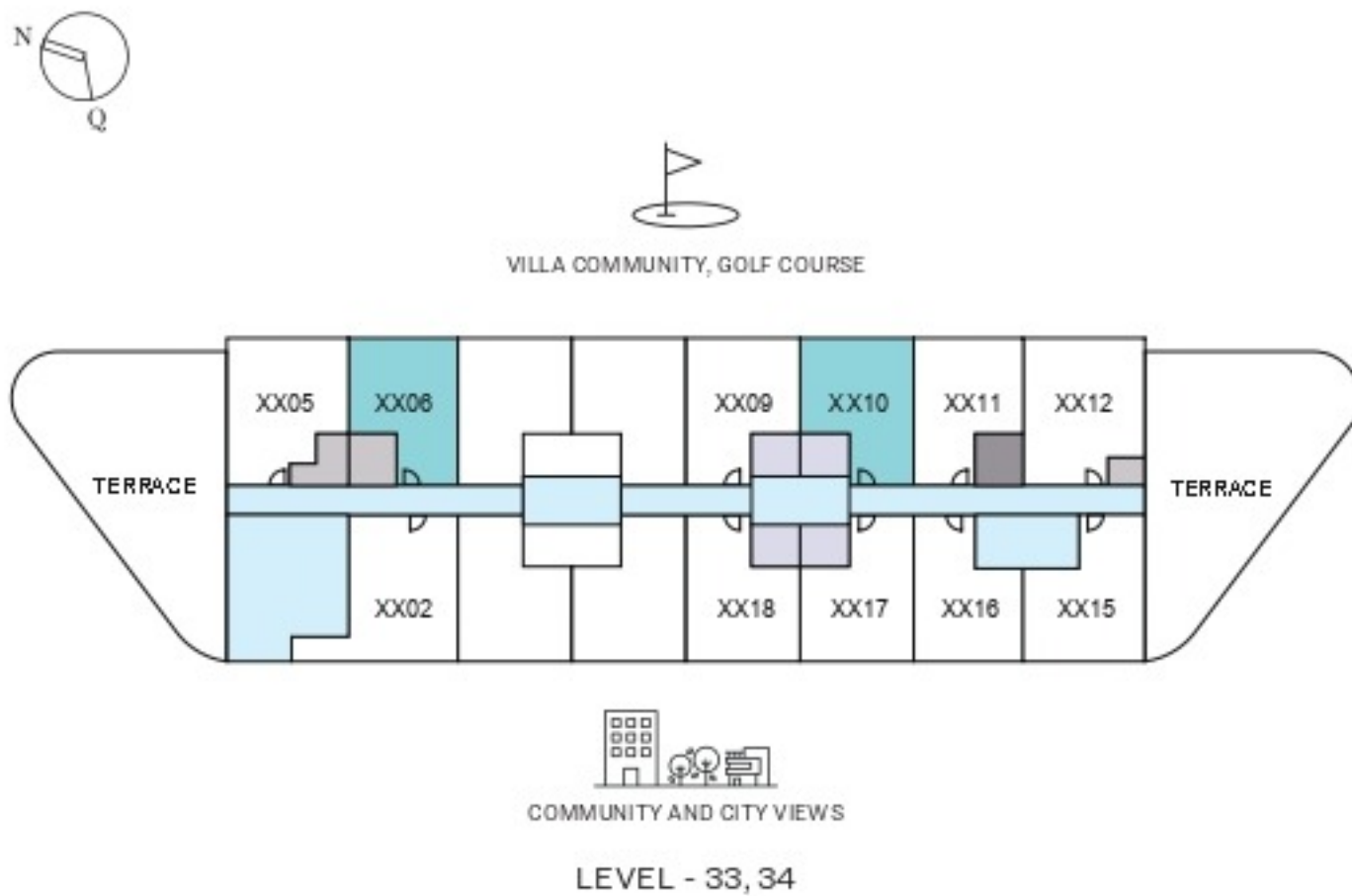
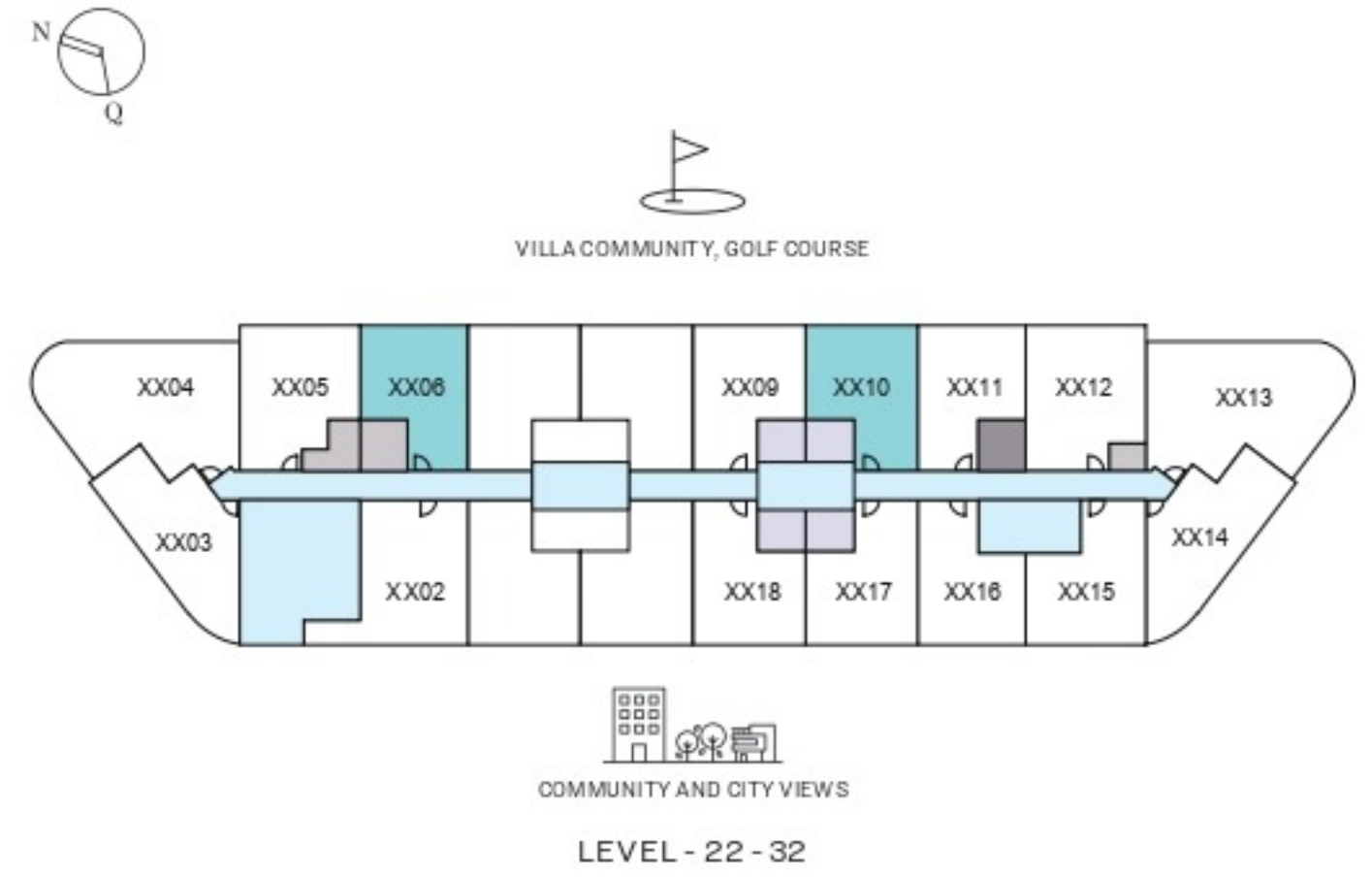
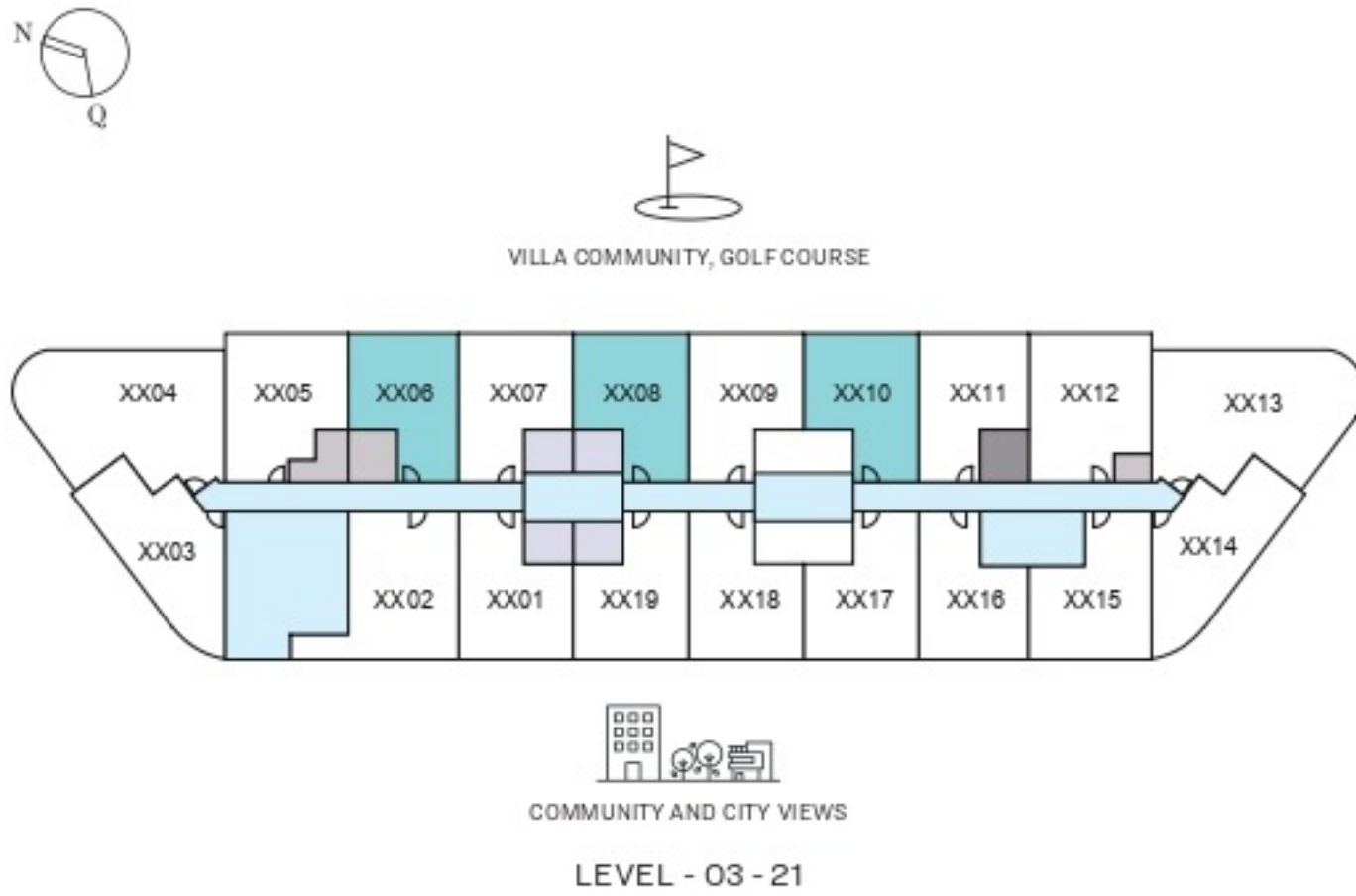

List of unit numbers with this unit plan:

VIEWS

Street View

A306, A308, A310, A406, A408, A410

Villa Community, Golf Course

A506, A508, A510, A606, A608, A610, A706, A708, A710, A806, A808, A810, A906, A908, A910, A1006, A1008, A1010, A1106, A1108, A1110, A1206, A1208, A1210, A1306, A1308, A1310, A1406, A1408, A1410, A1506, A1508, A1510, A1606, A1608, A1610, A1706, A1708, A1710, A1806, A1808, A1810, A1906, A1910, A2006, A2010, A2106, A2110, A2206, A2210, A2306, A2310, A2406, A2410, A2506, A2510, A2606, A2610, A2706, A2710, A2806, A2810, A2906, A2910, A3006, A3010, A3106, A3110, A3206, A3210, A3306, A3310, A3406, A3410

Disclaimer: 1. All dimensions are in metric, measured to wall finishes. 2. All materials, dimensions & drawings are approximate. 3. Information is subject to change without notice, at developer's absolute discretion. 4. Actual area may vary from the stated area. 5. Drawing are not to scale. 6. All images used are for illustrative purpose only and do not represent the actual size, features, specifications, fittings and furnishings. 7. The developer reserves the right to make revisions/ alterations, at its absolute discretion, without any liability whatsoever.

1 BEDROOM APARTMENT

TYPE A (with balcony) VARIANT 1

TOTAL SALEABLE AREA

SUITE RANGE = 486.96 SQ.FT. - 490.40 SQ.FT.

BALCONY = 56.51 SQ.FT.

TOTAL RANGE = 543.47 SQ.FT. - 546.91 SQ.FT.

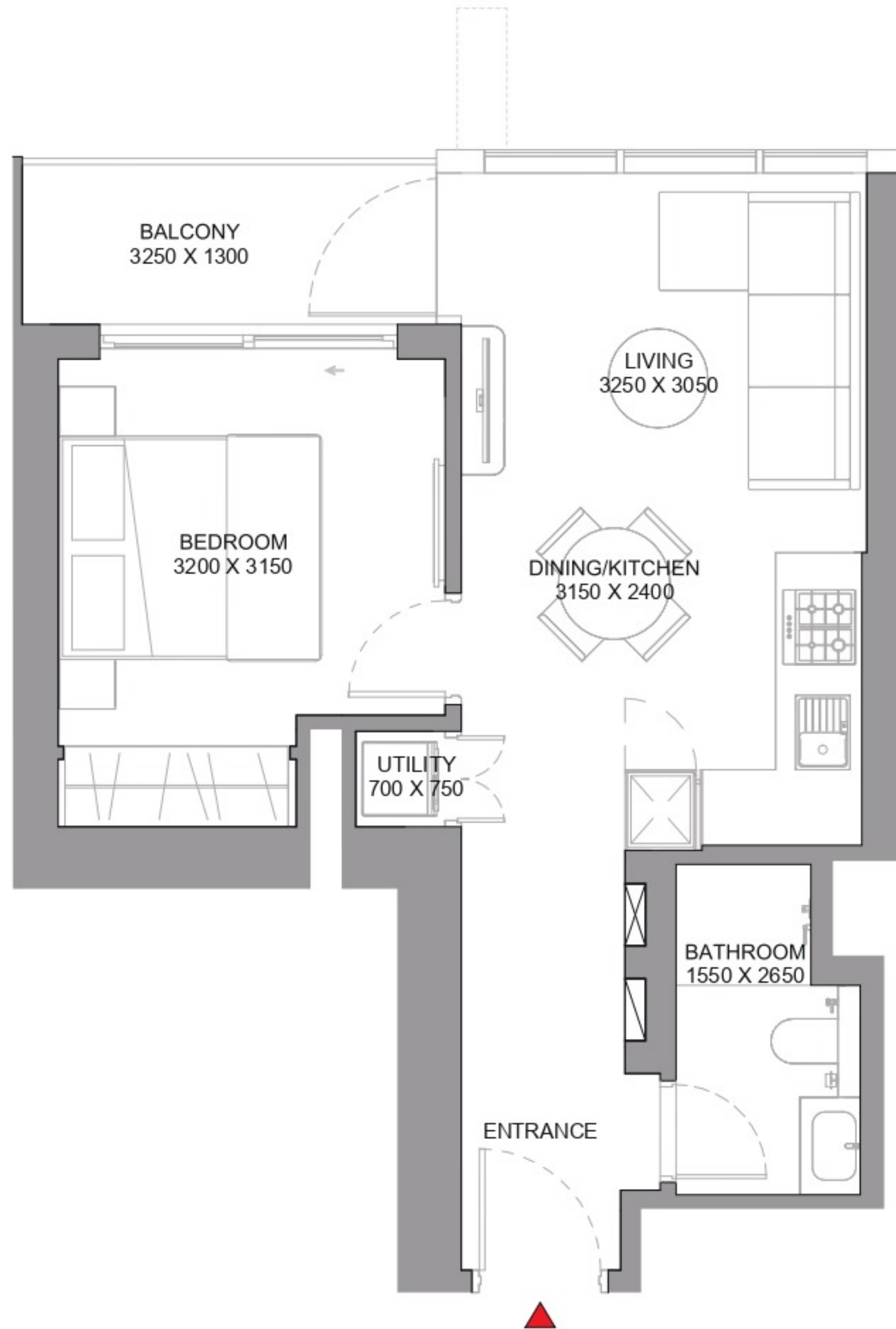

List of unit numbers with this unit plan:

VIEWS

Street View

A306, A308, A310, A406, A408, A410

Villa Community, Golf Course

A506, A508, A510, A606, A608, A610, A706, A708, A710, A806, A808, A810, A906, A908, A910, A1006, A1008, A1010, A1106, A1108, A1110, A1206, A1208, A1210, A1306, A1308, A1310, A1406, A1408, A1410, A1506, A1508, A1510, A1606, A1608, A1610, A1706, A1708, A1710, A1806, A1808, A1810, A1906, A1910, A2006, A2010, A2106, A2110, A2206, A2210, A2306, A2310, A2406, A2410, A2506, A2510, A2606, A2610, A2706, A2710, A2806, A2810, A2906, A2910, A3006, A3010, A3106, A3110, A3206, A3210, A3306, A3310, A3406, A3410

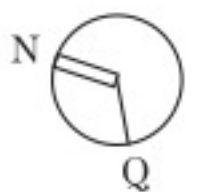

1 BEDROOM APARTMENT

TYPE B (with balcony)

TOTAL SALEABLE AREA

SUITE = 491.16 SQ.FT.
BALCONY = 54.14 SQ.FT.
TOTAL = 545.30 SQ.FT.

UNIT

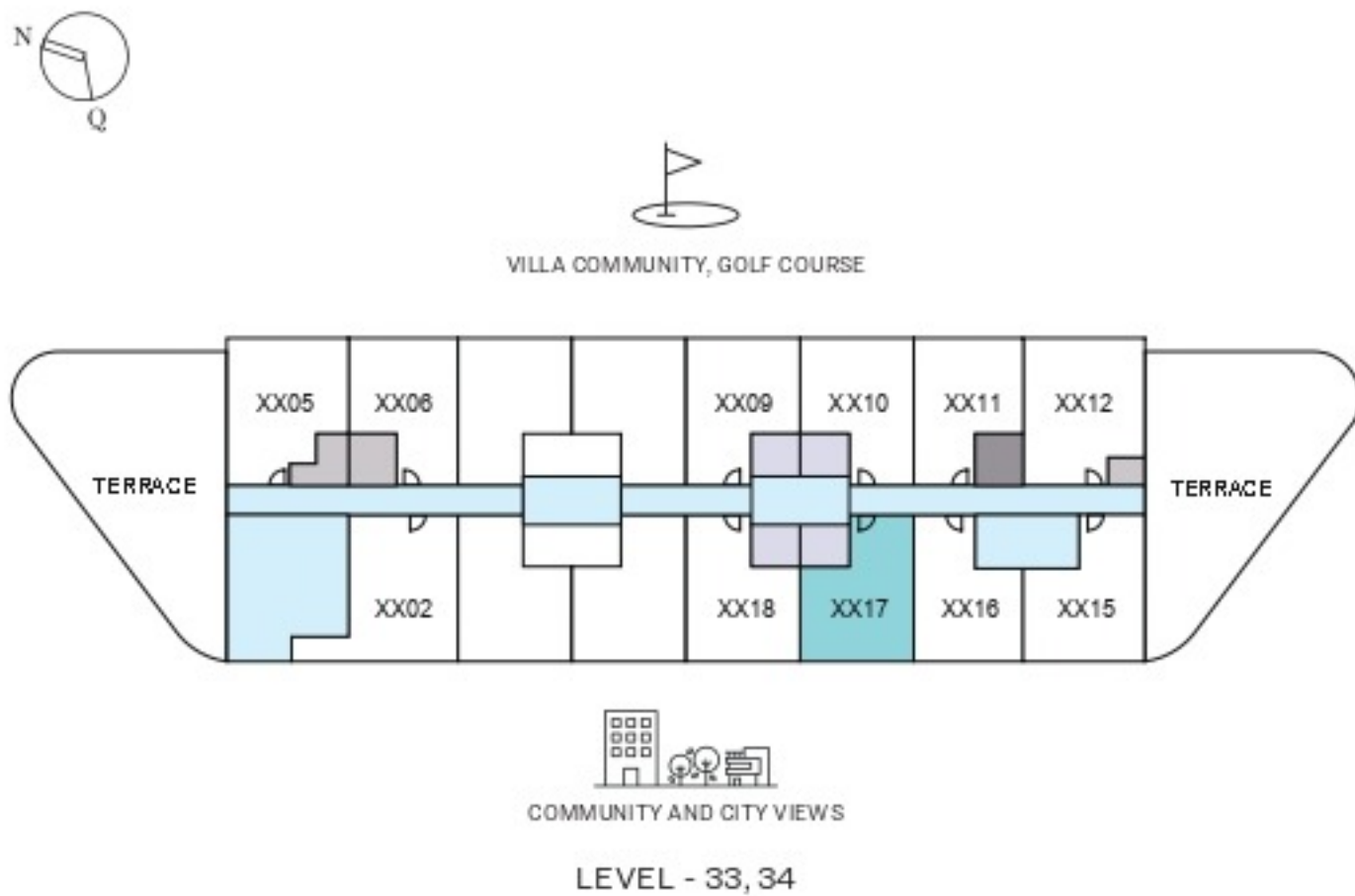
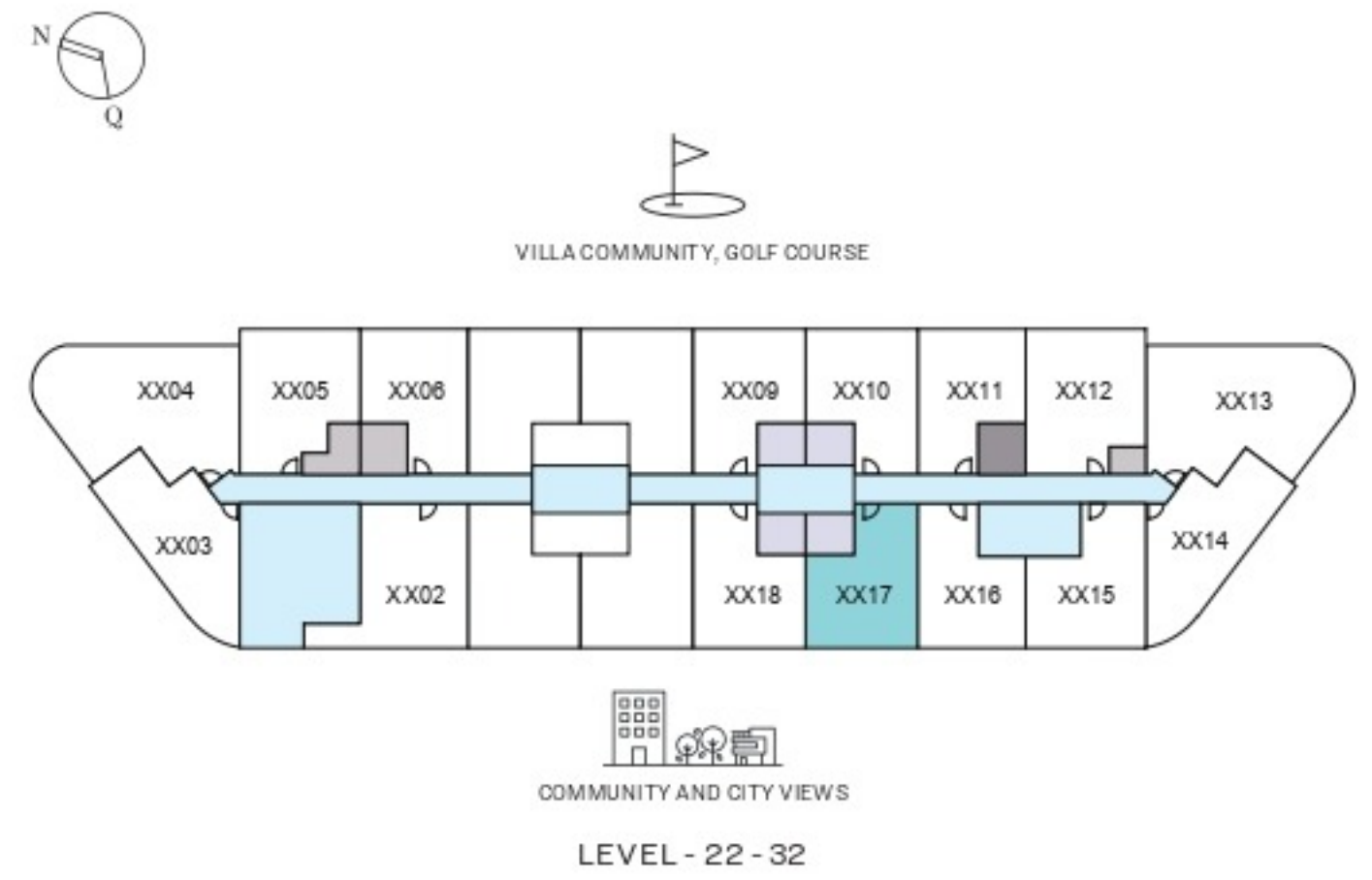
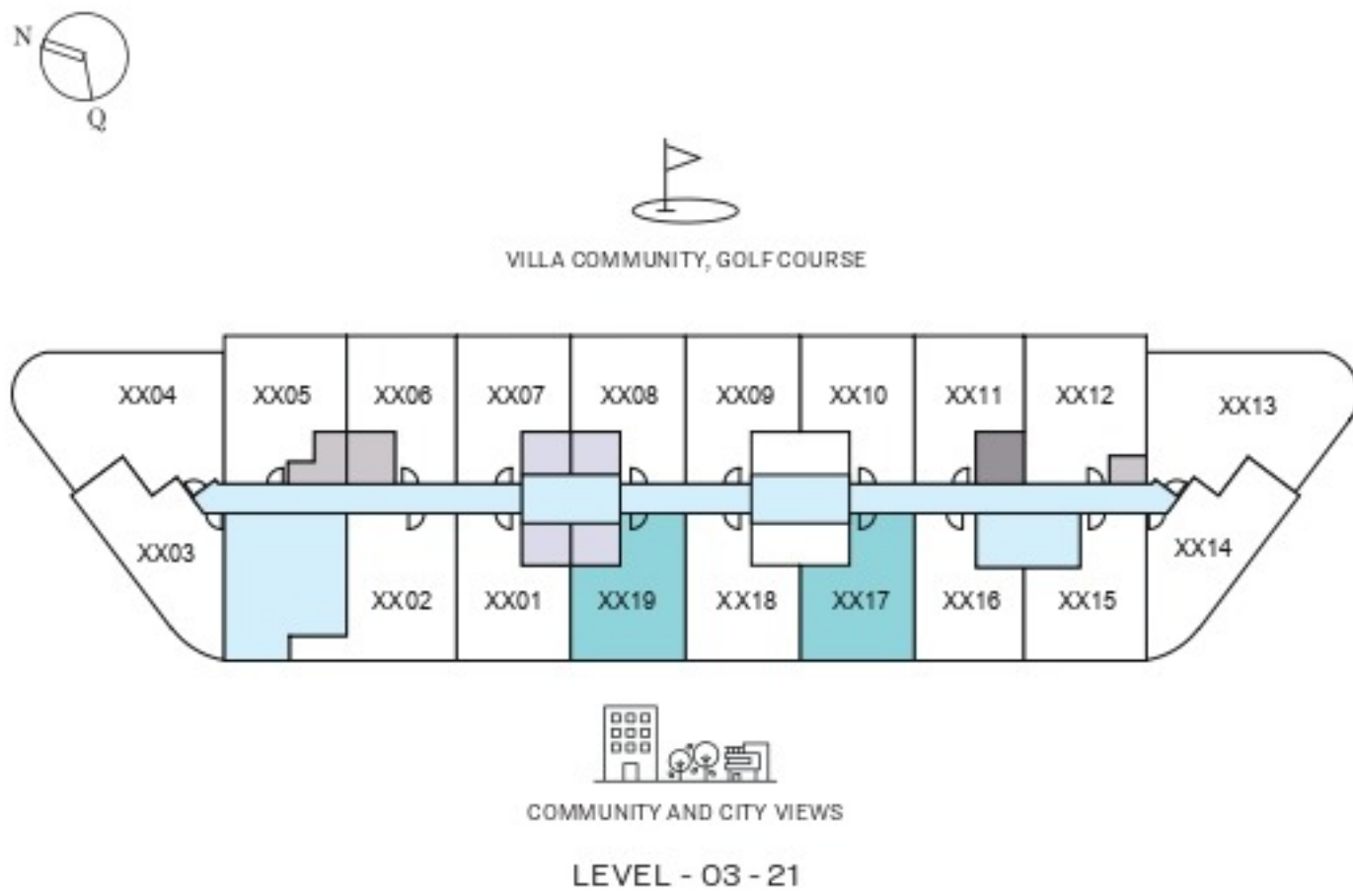

List of unit numbers with this unit plan:

VIEWS

Amenities

A317, A319, A417, A419, A517, A519, A617, A619, A717, A719, A817, A819, A917, A919, A1017, A1019, A1117, A1119, A1217, A1219, A1317, A1319, A1417, A1419, A1517, A1519, A1617, A1619, A1717, A1719, A1817, A1819, A1917, A2017

Community, City View

A2117, A2217, A2317, A2417, A2517, A2617, A2717, A2817, A2917, A3017, A3117, A3217, A3317, A3417

Disclaimer: 1. All dimensions are in metric, measured to wall finishes. 2. All materials, dimensions & drawings are approximate. 3. Information is subject to change without notice, at developer's absolute discretion. 4. Actual area may vary from the stated area. 5. Drawing are not to scale. 6. All images used are for illustrative purpose only and do not represent the actual size, features, specifications, fittings and furnishings. 7. The developer reserves the right to make revisions/ alterations, at its absolute discretion, without any liability whatsoever.

1 BEDROOM APARTMENT

TYPE B (with balcony)

TOTAL SALEABLE AREA

SUITE = 491.16 SQ.FT.
BALCONY = 54.14 SQ.FT.
TOTAL = 545.30 SQ.FT.

■ UNIT

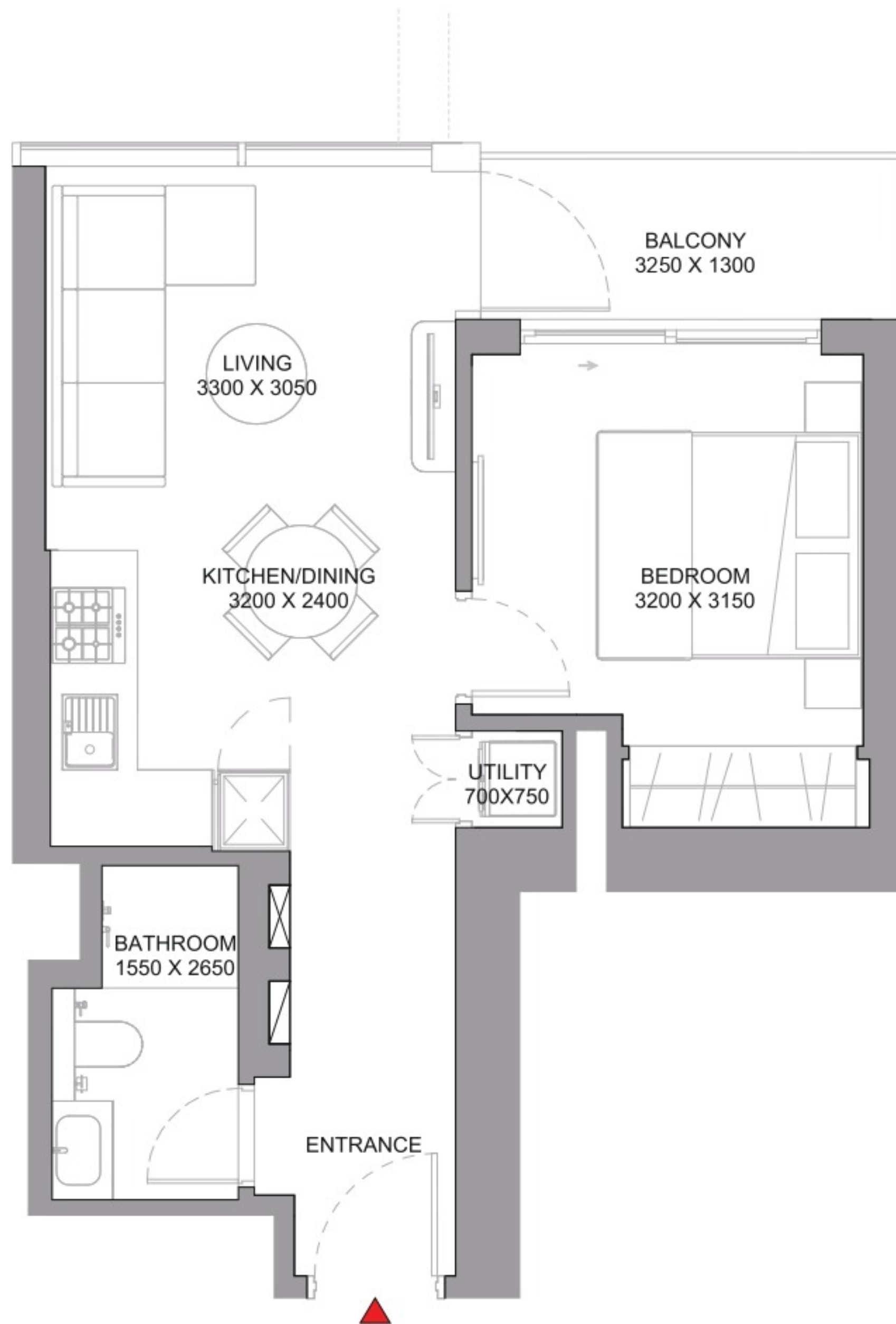

List of unit numbers with this unit plan:

VIEWS

Amenities

A317, A319, A417, A419, A517, A519, A617, A619, A717, A719, A817, A819, A917, A919, A1017, A1019, A1117, A1119, A1217, A1219, A1317, A1319, A1417, A1419, A1517, A1519, A1617, A1619, A1717, A1719, A1817, A1819, A1917, A2017

Community, City View

A2117, A2217, A2317, A2417, A2517, A2617, A2717, A2817, A2917, A3017, A3117, A3217, A3317, A3417

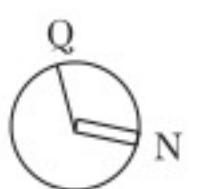

1 BEDROOM APARTMENT

TYPE B (with balcony) VARIANT 1

TOTAL SALEABLE AREA

SUITE RANGE = 490.40 SQ.FT. - 490.62 SQ.FT.

BALCONY = 56.51 SQ.FT.

TOTAL RANGE = 546.91 SQ.FT. - 547.13 SQ.FT.

 UNIT

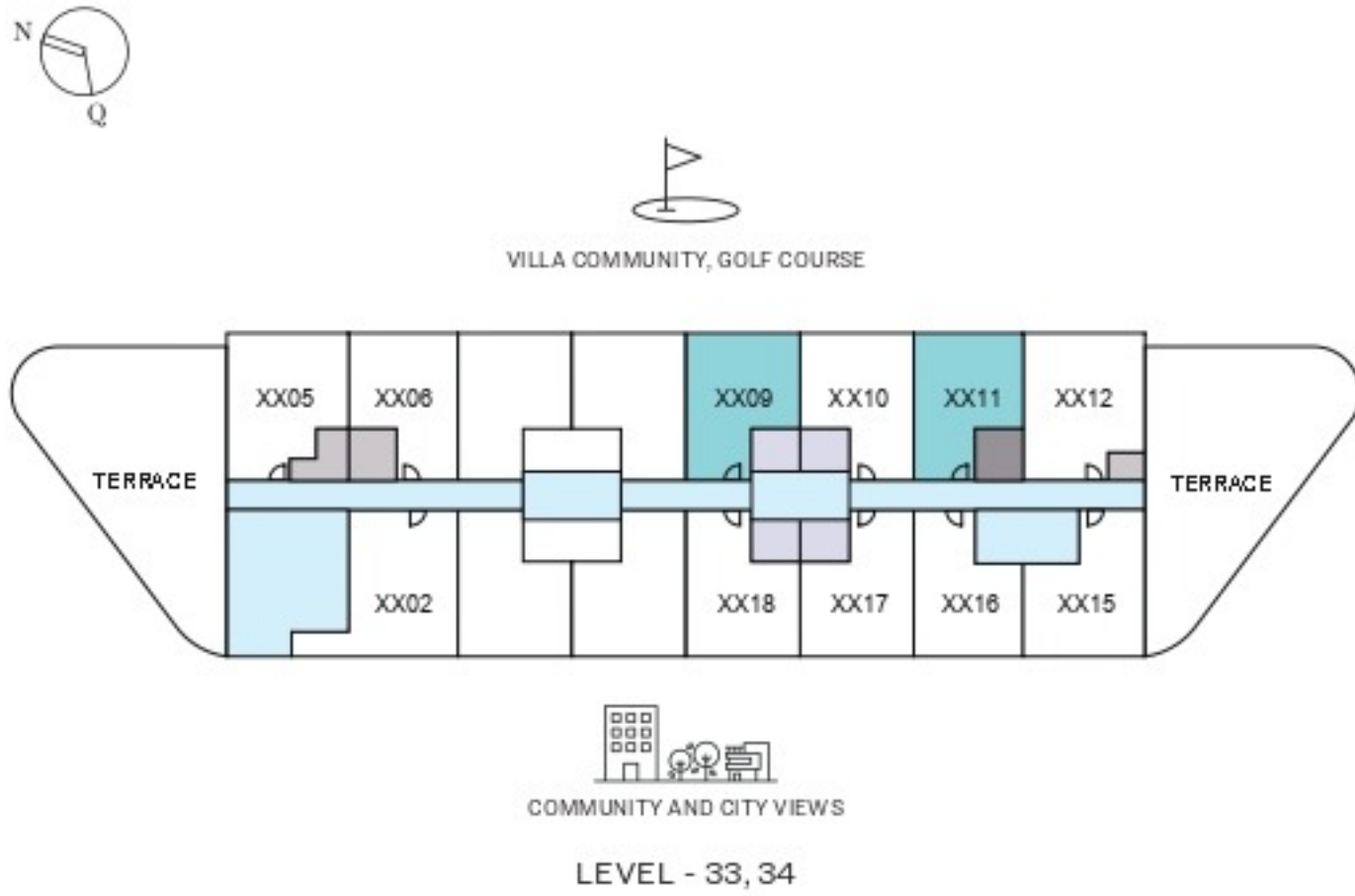
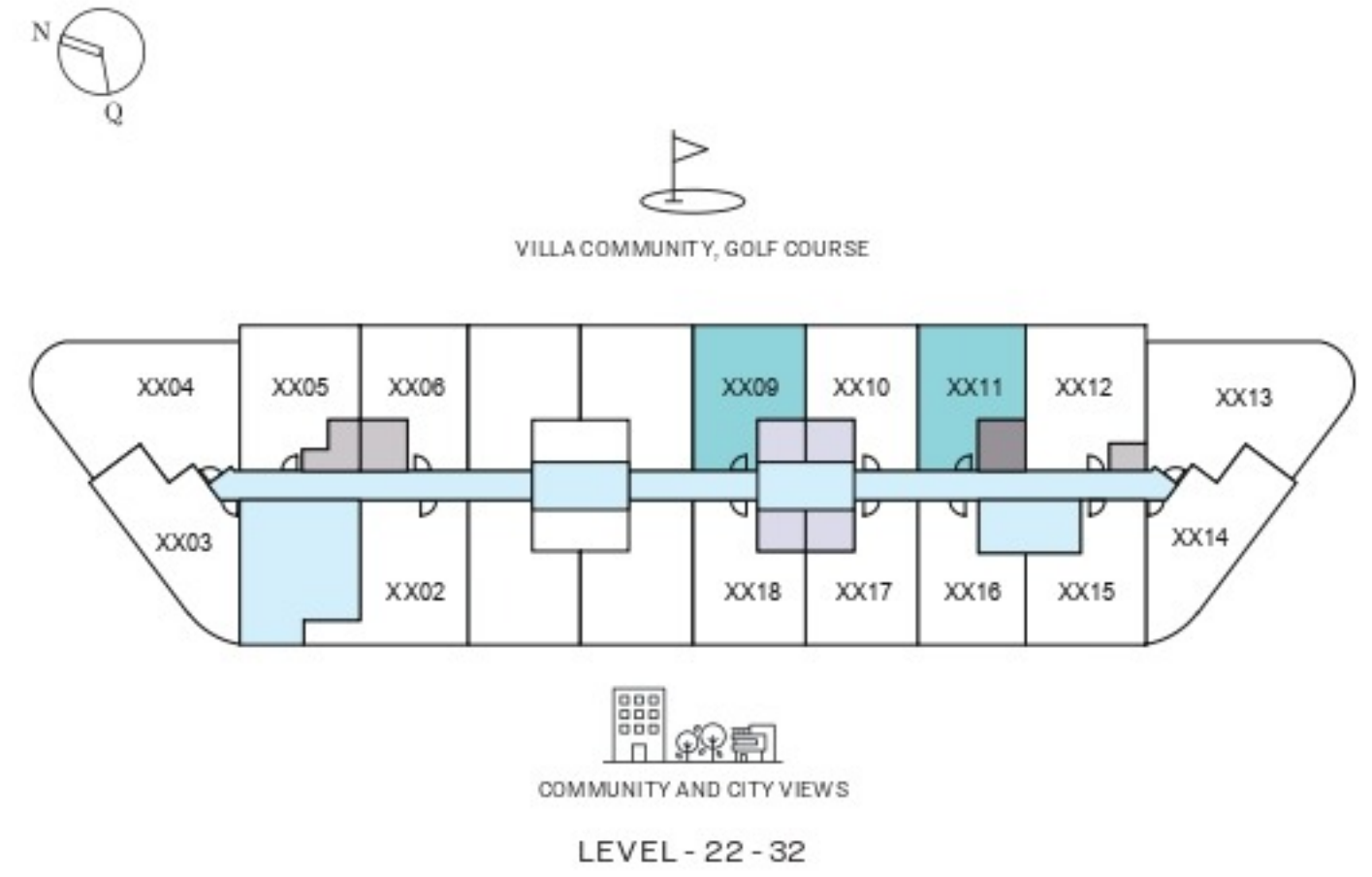
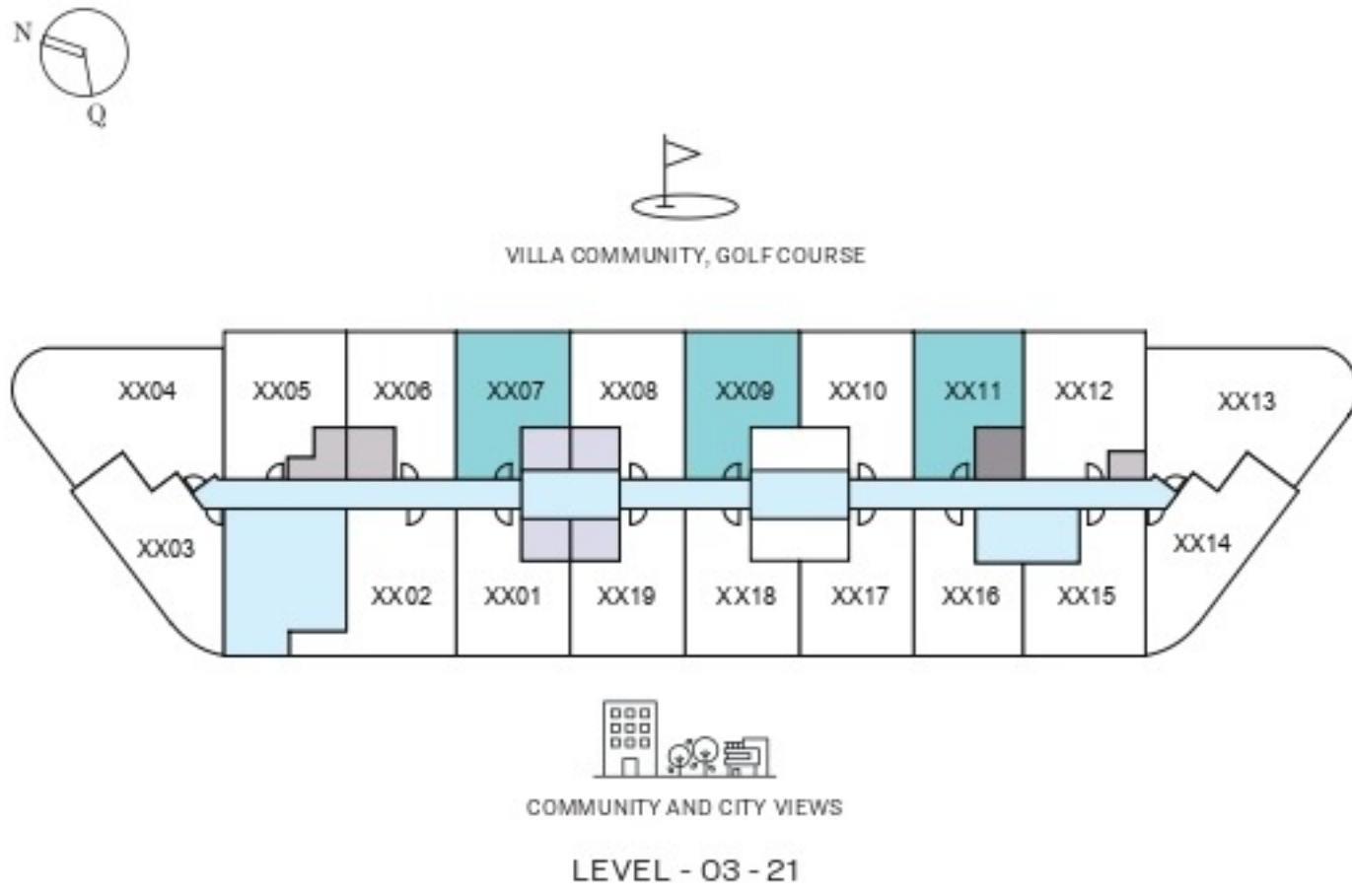

List of unit numbers with this unit plan:

VIEWS

Street View

A307, A309, A311, A407, A409, A411

Villa Community, Golf Course

A507, A509, A511, A607, A609, A611, A707, A709, A711, A807, A809, A811, A907, A909, A911, A1007, A1009, A1011, A1107, A1109, A1111, A1207, A1209, A1211, A1307, A1309, A1311, A1407, A1409, A1411, A1507, A1509, A1511, A1607, A1609, A1611, A1707, A1709, A1711, A1807, A1809, A1811, A1909, A1911, A2009, A2011, A2109, A2111, A2209, A2211, A2309, A2311, A2409, A2411, A2509, A2511, A2609, A2611, A2709, A2711, A2809, A2811, A2909, A2911, A3009, A3011, A3109, A3111, A3209, A3211, A3309, A3311, A3409, A3411

Disclaimer: 1. All dimensions are in metric, measured to wall finishes. 2. All materials, dimensions & drawings are approximate. 3. Information is subject to change without notice, at developer's absolute discretion. 4. Actual area may vary from the stated area. 5. Drawing are not to scale. 6. All images used are for illustrative purpose only and do not represent the actual size, features, specifications, fittings and furnishings. 7. The developer reserves the right to make revisions/ alterations, at its absolute discretion, without any liability whatsoever.

1 BEDROOM APARTMENT

TYPE B (with balcony) VARIANT 1

TOTAL SALEABLE AREA

SUITE RANGE = 490.40 SQ.FT. - 490.62 SQ.FT.

BALCONY = 56.51 SQ.FT.

TOTAL RANGE = 546.91 SQ.FT. - 547.13 SQ.FT.

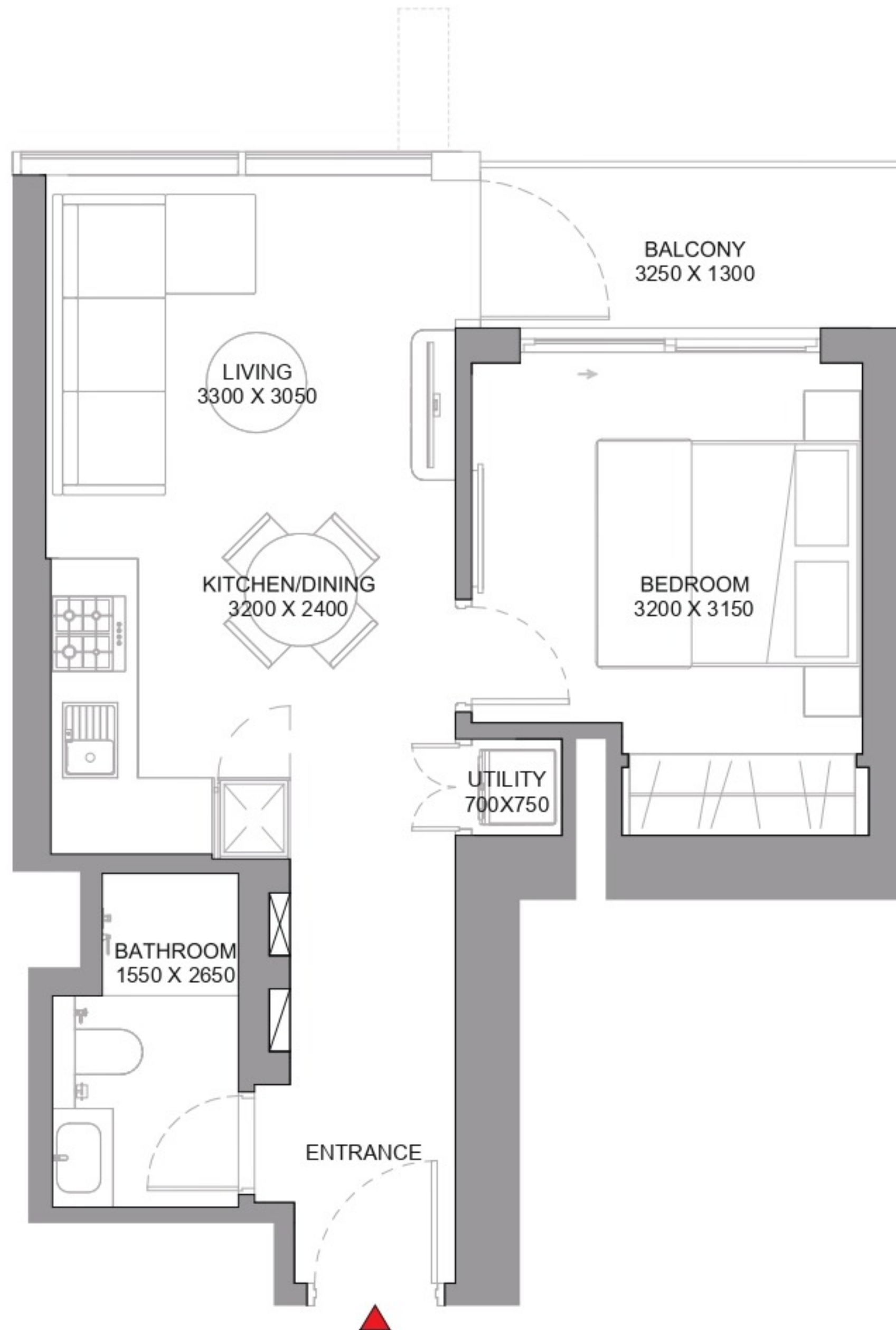

List of unit numbers with this unit plan:

VIEWS

Street View

A307, A309, A311, A407, A409, A411

Villa Community, Golf Course

A507, A509, A511, A607, A609, A611, A707, A709, A711, A807, A809, A811, A907, A909, A911, A1007, A1009, A1011, A1107, A1109, A1111, A1207, A1209, A1211, A1307, A1309, A1311, A1407, A1409, A1411, A1507, A1509, A1511, A1607, A1609, A1611, A1707, A1709, A1711, A1807, A1809, A1811, A1909, A1911, A2009, A2011, A2109, A2111, A2209, A2211, A2309, A2311, A2409, A2411, A2509, A2511, A2609, A2611, A2709, A2711, A2809, A2811, A2909, A2911, A3009, A3011, A3109, A3111, A3209, A3211, A3309, A3311, A3409, A3411

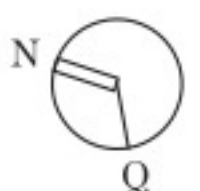

Disclaimer: 1. All dimensions are in metric, measured to wall finishes. 2. All materials, dimensions & drawings are approximate. 3. Information is subject to change without notice, at developer's absolute discretion. 4. Actual area may vary from the stated area. 5. Drawing are not to scale. 6. All images used are for illustrative purpose only and do not represent the actual size, features, specifications, fittings and furnishings. 7. The developer reserves the right to make revisions/ alterations, at its absolute discretion, without any liability whatsoever.

1 BEDROOM APARTMENT

TYPE C (with store room + balcony)

TOTAL SALEABLE AREA

SUITE = 524.31 SQ.FT.
BALCONY = 56.51 SQ.FT.
TOTAL = 580.82 SQ.FT.

 UNIT

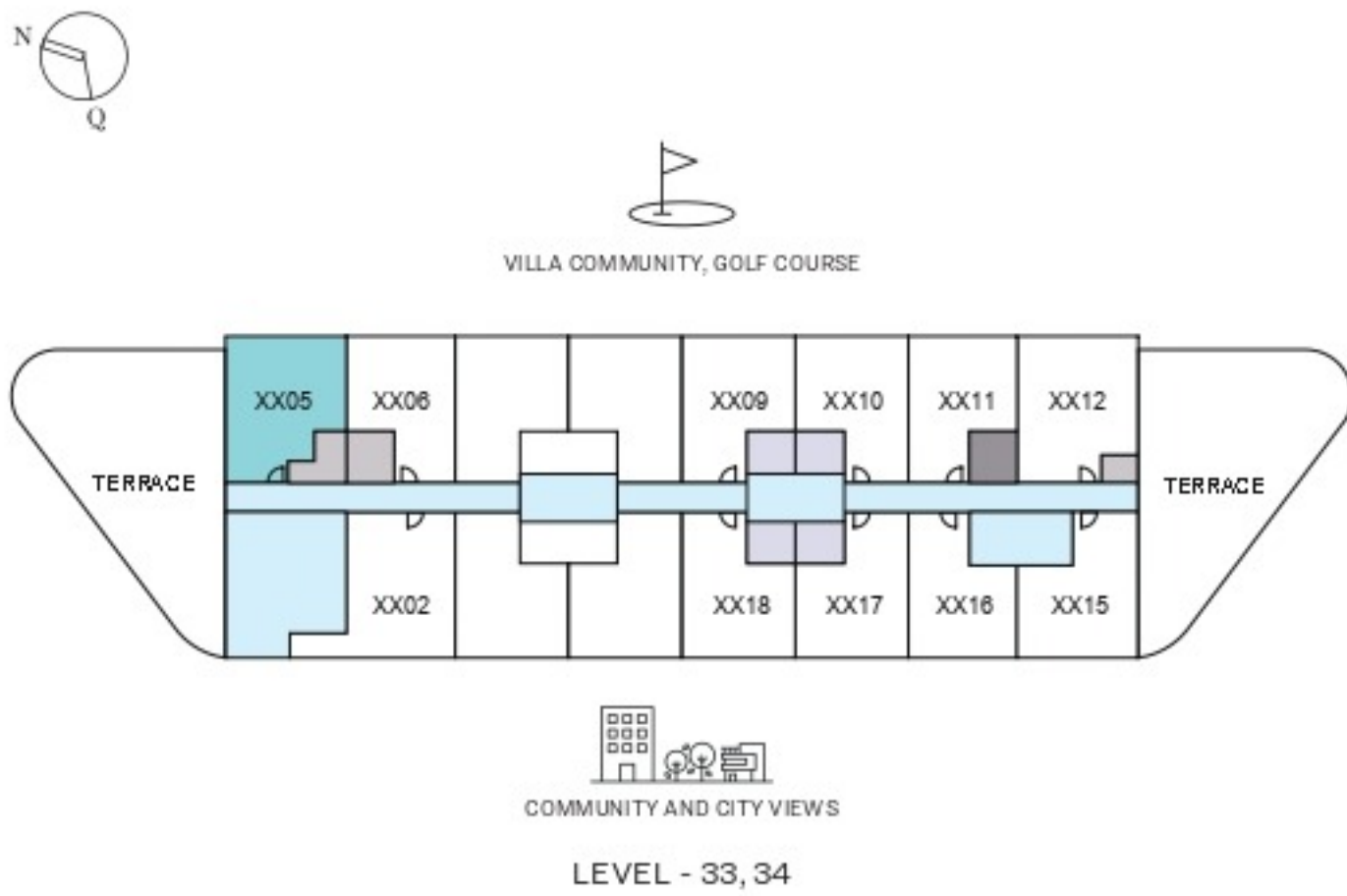
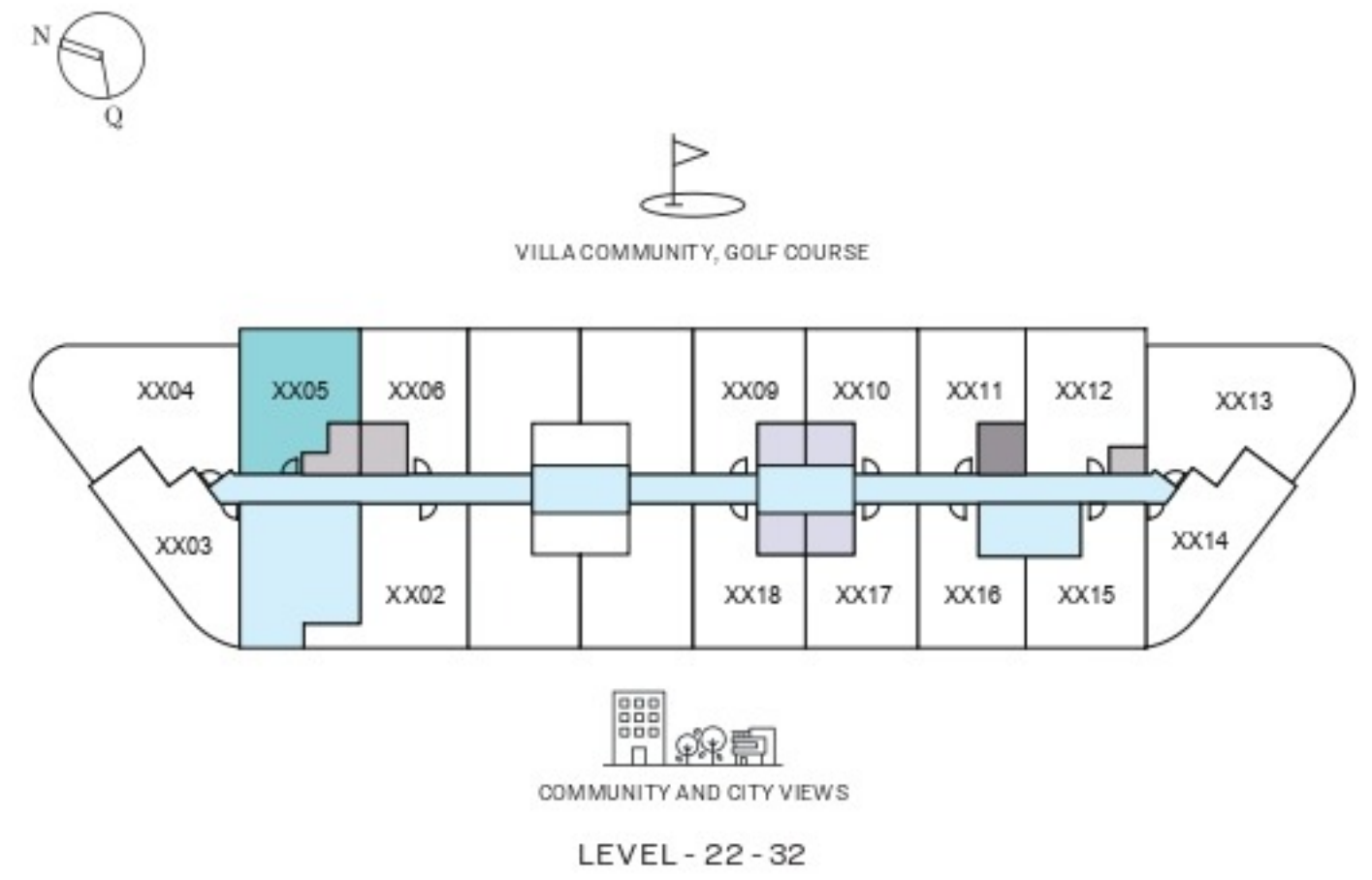
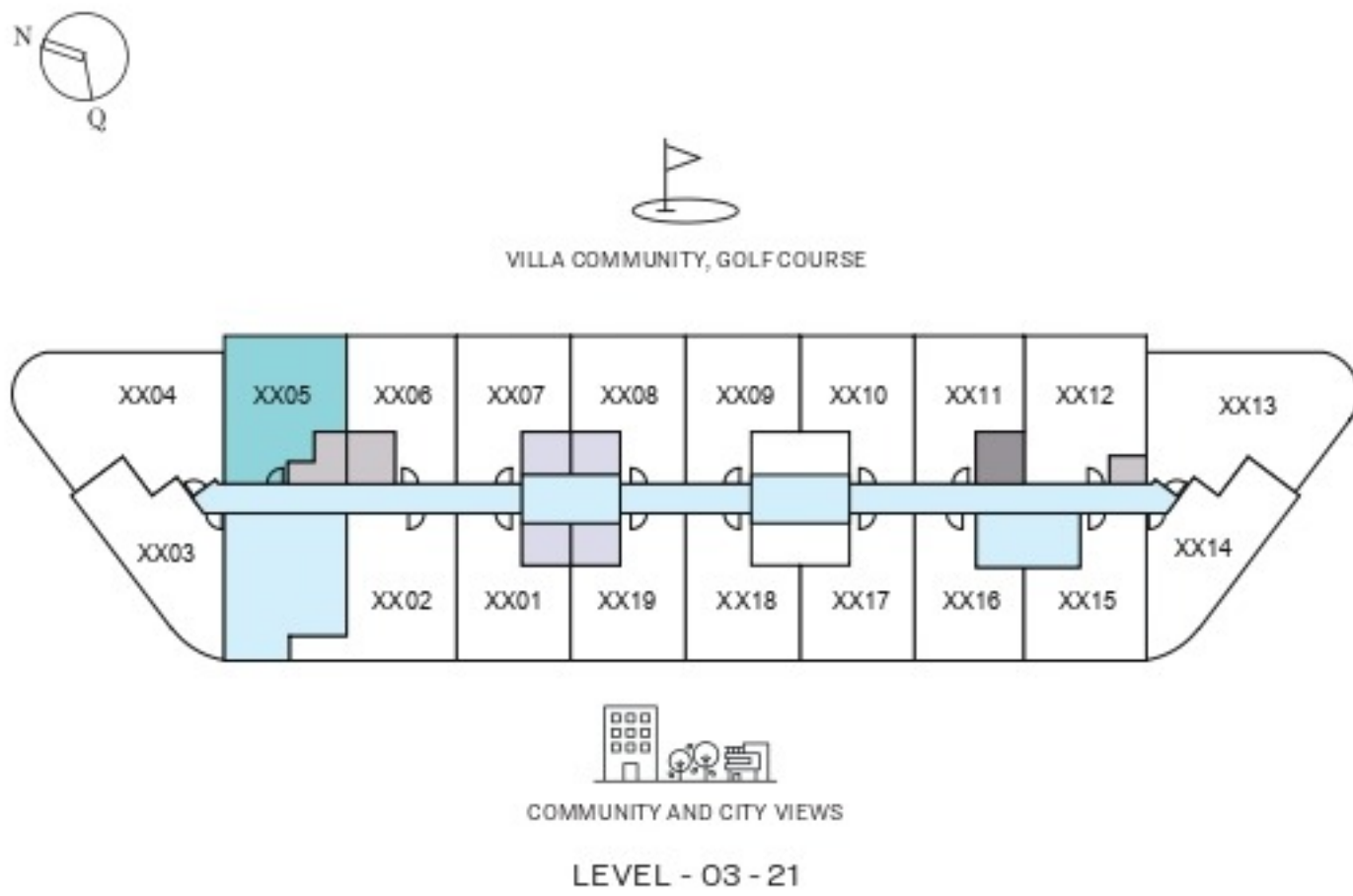

List of unit numbers with this unit plan:

VIEWS

Street View

A305, A405

Villa Community, Golf Course

A505, A605, A705, A805, A1305, A1405, A1505, A1605, A1705, A1805, A2105, A2205, A2505, A2605, A2705, A2805, A3105, A3205, A3305, A3405

Disclaimer: 1. All dimensions are in metric, measured to wall finishes. 2. All materials, dimensions & drawings are approximate. 3. Information is subject to change without notice, at developer's absolute discretion. 4. Actual area may vary from the stated area. 5. Drawing are not to scale. 6. All images used are for illustrative purpose only and do not represent the actual size, features, specifications, fittings and furnishings. 7. The developer reserves the right to make revisions/ alterations, at its absolute discretion, without any liability whatsoever.

1 BEDROOM APARTMENT

TYPE C (with store room + balcony)

TOTAL SALEABLE AREA

SUITE = 524.31 SQ.FT.
BALCONY = 56.51 SQ.FT.
TOTAL = 580.82 SQ.FT.

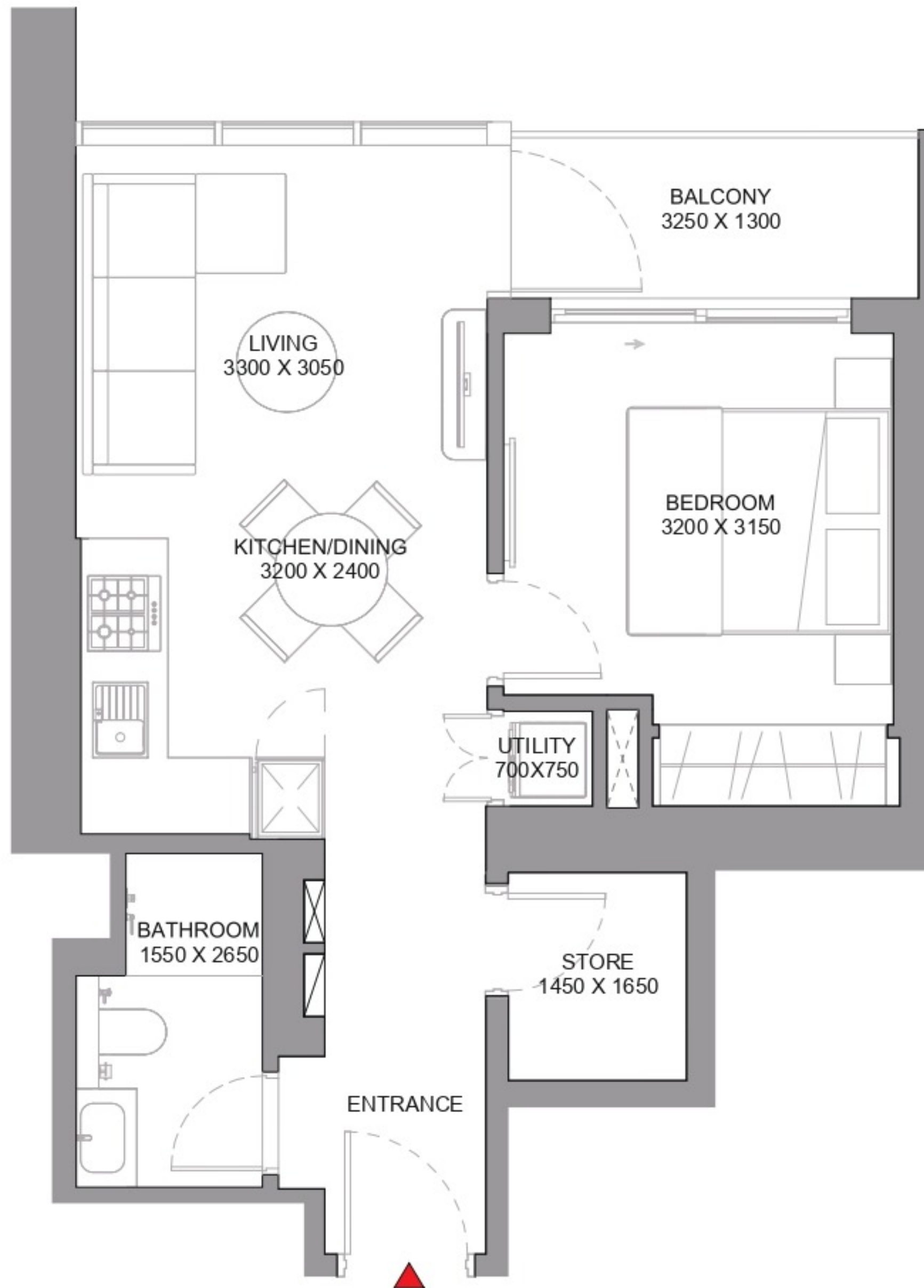

List of unit numbers with this unit plan:

VIEWS

Street View
A305, A405

Villa Community, Golf Course

A505, A605, A705, A805, A1305, A1405, A1505, A1605, A1705, A1805, A2105, A2205, A2505,
A2605, A2705, A2805, A3105, A3205, A3305, A3405

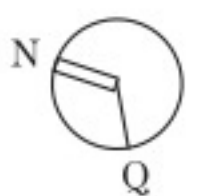

1 BEDROOM APARTMENT

TYPE D (with balcony)

TOTAL SALEABLE AREA

SUITE = 484.27 SQ.FT.

BALCONY = 54.14 SQ.FT.

TOTAL = 538.41 SQ.FT.

 UNIT

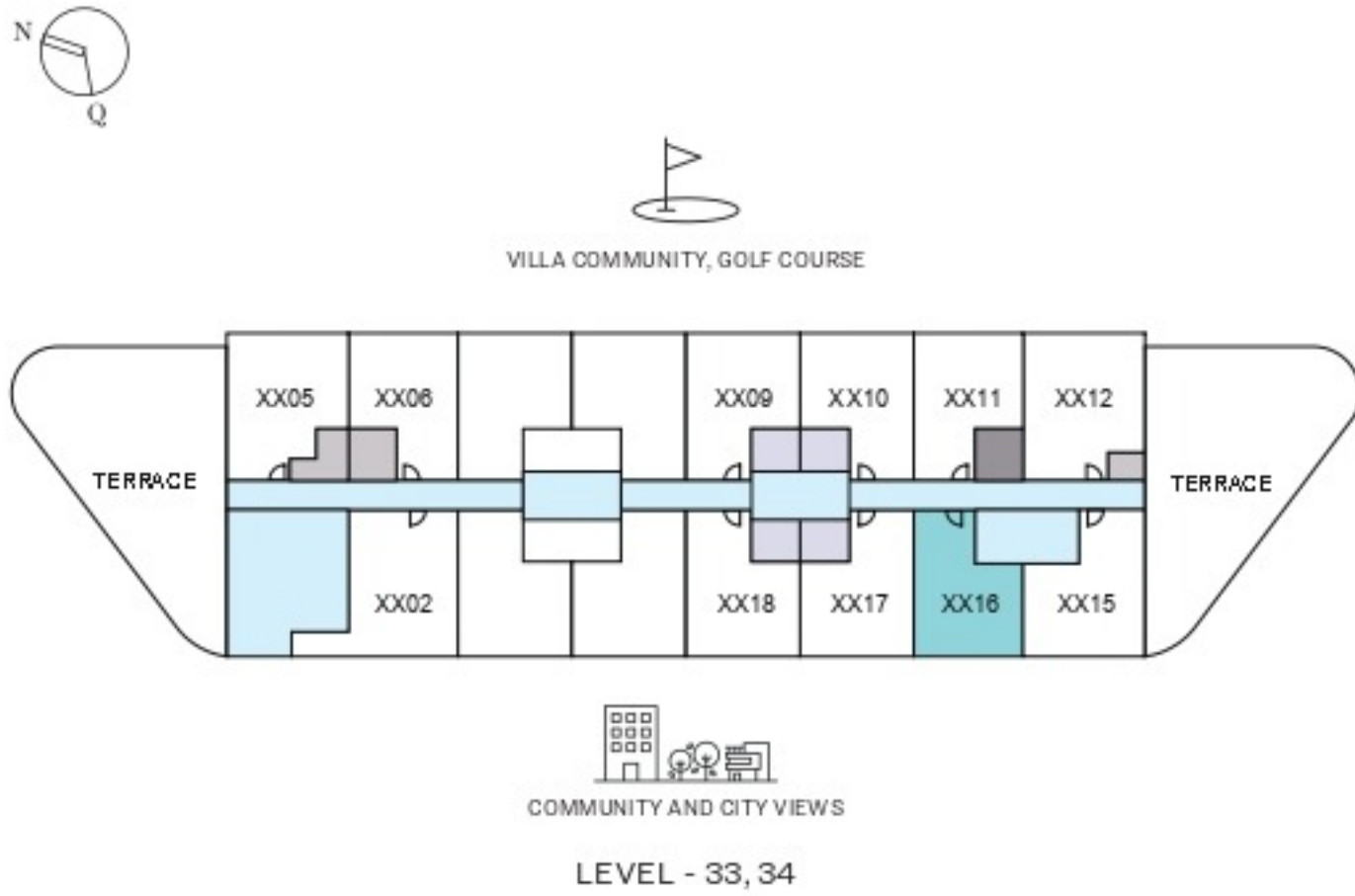
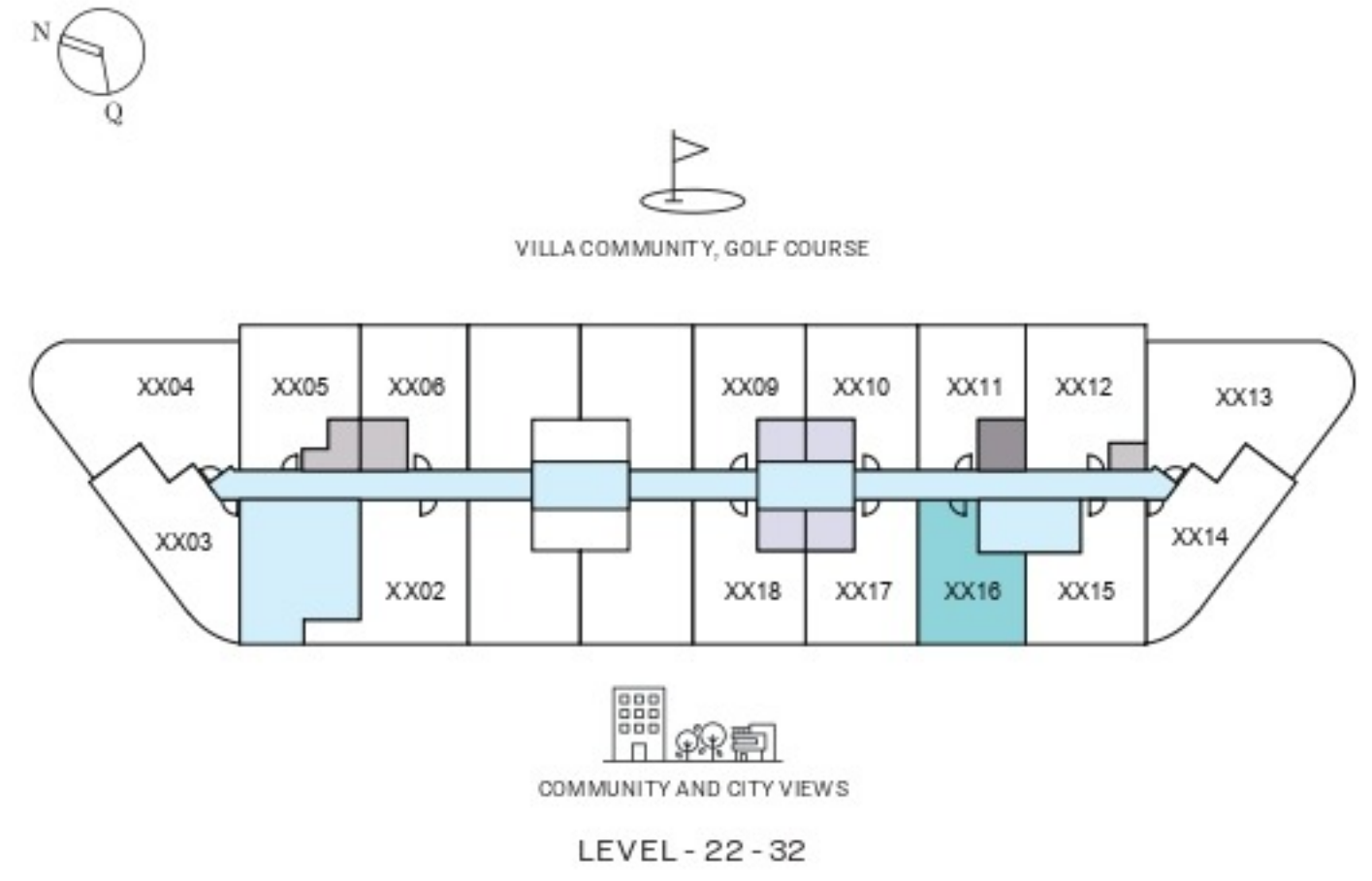
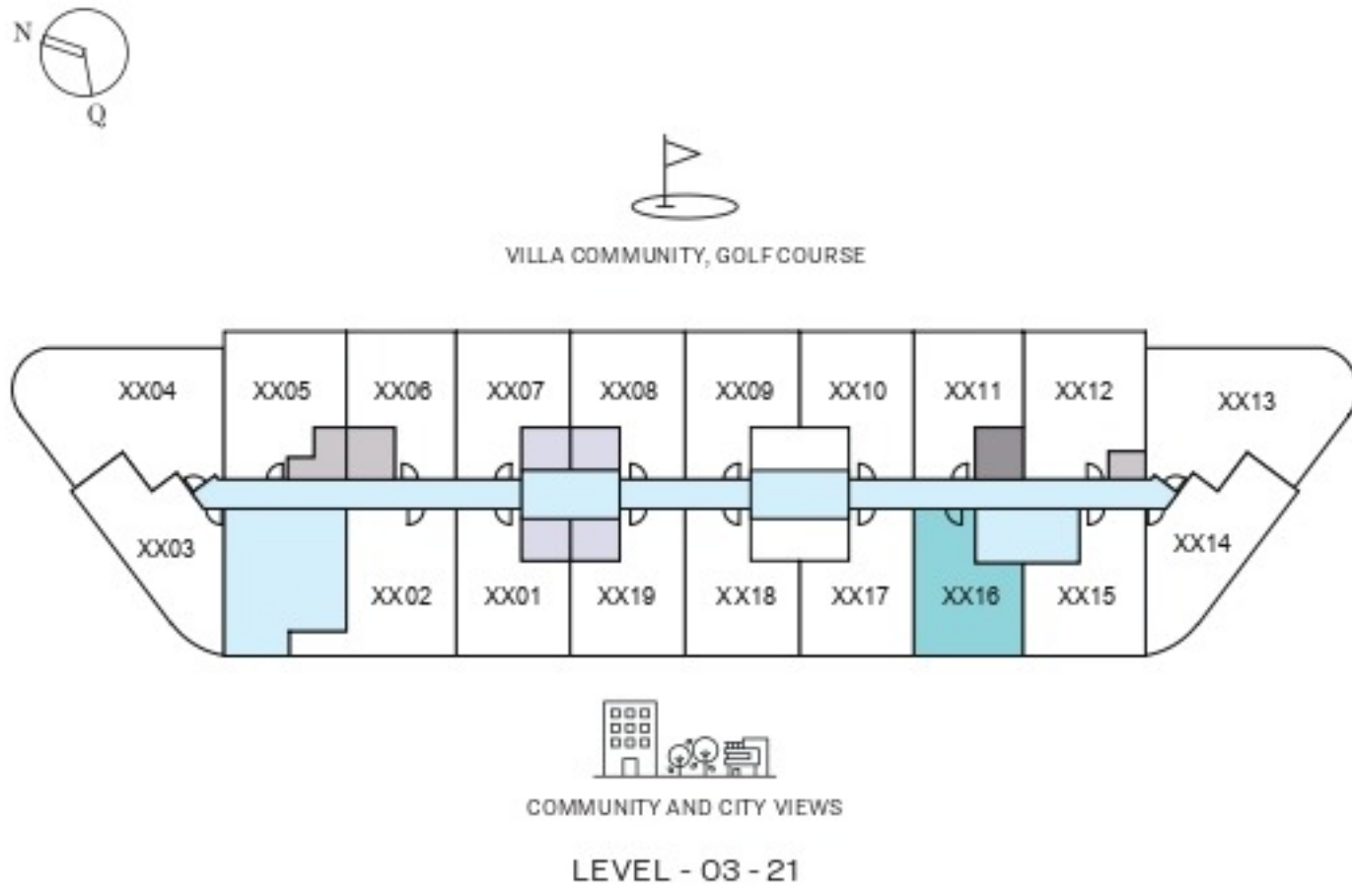

List of unit numbers with this unit plan:

VIEWS

Amenities

A316, A416, A516, A616, A716, A816, A916, A1016, A1116, A1216, A1316, A1416, A1516, A1616, A1716, A1816, A1916, A2016

Community, City View

A2116, A2216, A2316, A2416, A2516, A2616, A2716, A2816, A2916, A3016, A3116, A3216, A3316, A3416

Disclaimer: 1. All dimensions are in metric, measured to wall finishes. 2. All materials, dimensions & drawings are approximate. 3. Information is subject to change without notice, at developer's absolute discretion. 4. Actual area may vary from the stated area. 5. Drawing are not to scale. 6. All images used are for illustrative purpose only and do not represent the actual size, features, specifications, fittings and furnishings. 7. The developer reserves the right to make revisions/ alterations, at its absolute discretion, without any liability whatsoever.

1 BEDROOM APARTMENT

TYPE D (with balcony)

TOTAL SALEABLE AREA

SUITE = 484.27 SQ.FT.

BALCONY = 54.14 SQ.FT.

TOTAL = 538.41 SQ.FT.

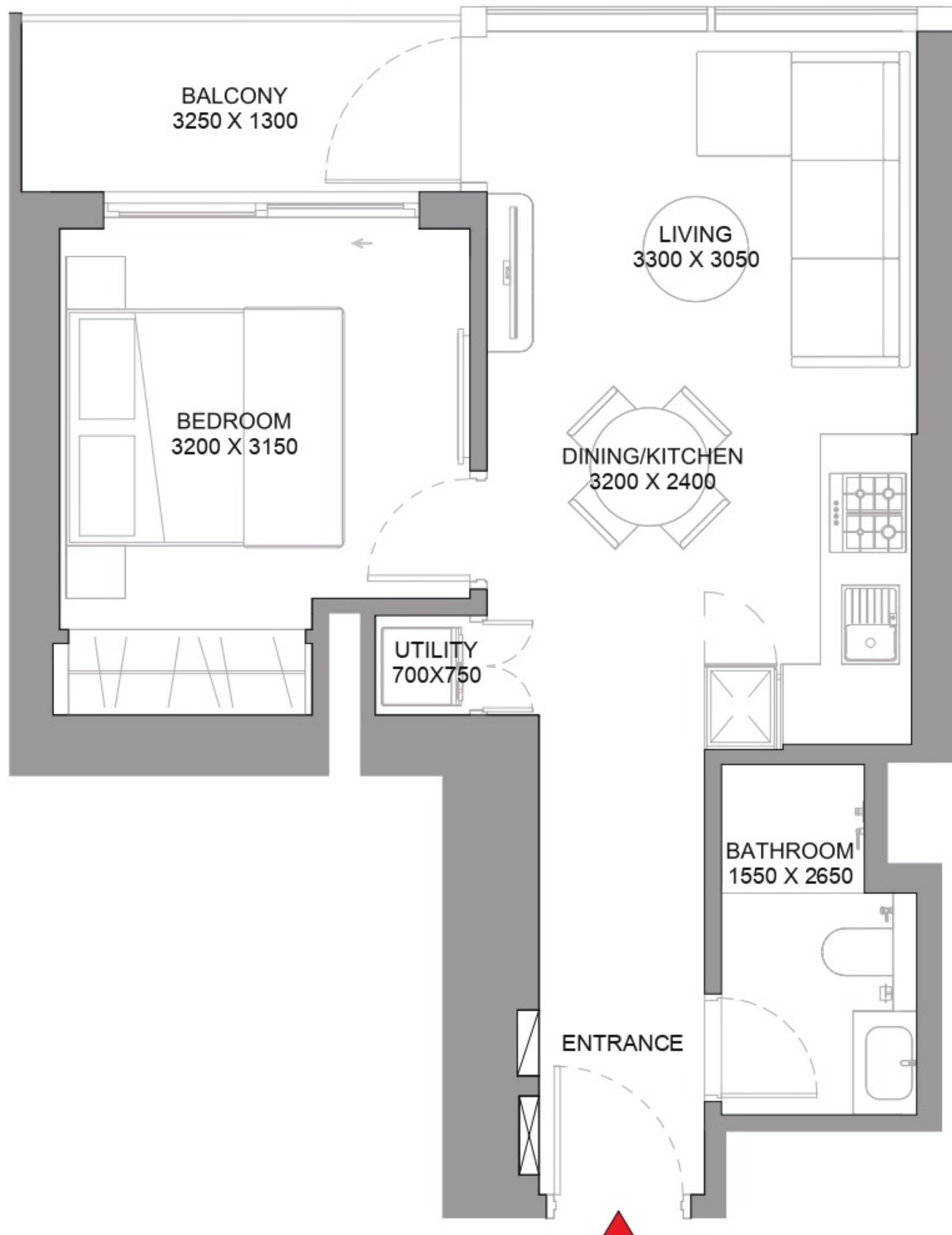

List of unit numbers with this unit plan:

VIEWS

Amenities

A316, A416, A516, A616, A716, A816, A916, A1016, A1116, A1216, A1316, A1416, A1516, A1616, A1716, A1816, A1916, A2016

Community, City View

A2116, A2216, A2316, A2416, A2516, A2616, A2716, A2816, A2916, A3016, A3116, A3216, A3316, A3416

Disclaimer: 1. All dimensions are in metric, measured to wall finishes. 2. All materials, dimensions & drawings are approximate. 3. Information is subject to change without notice, at developer's absolute discretion. 4. Actual area may vary from the stated area. 5. Drawing are not to scale. 6. All images used are for illustrative purpose only and do not represent the actual size, features, specifications, fittings and furnishings. 7. The developer reserves the right to make revisions/ alterations, at its absolute discretion, without any liability whatsoever.

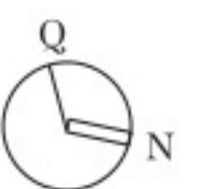

1 BEDROOM APARTMENT

TYPE E (with balcony)

TOTAL SALEABLE AREA

SUITE = 485.56 SQ.FT.

BALCONY = 54.14 SQ.FT.

TOTAL = 539.70 SQ.FT.

 UNIT

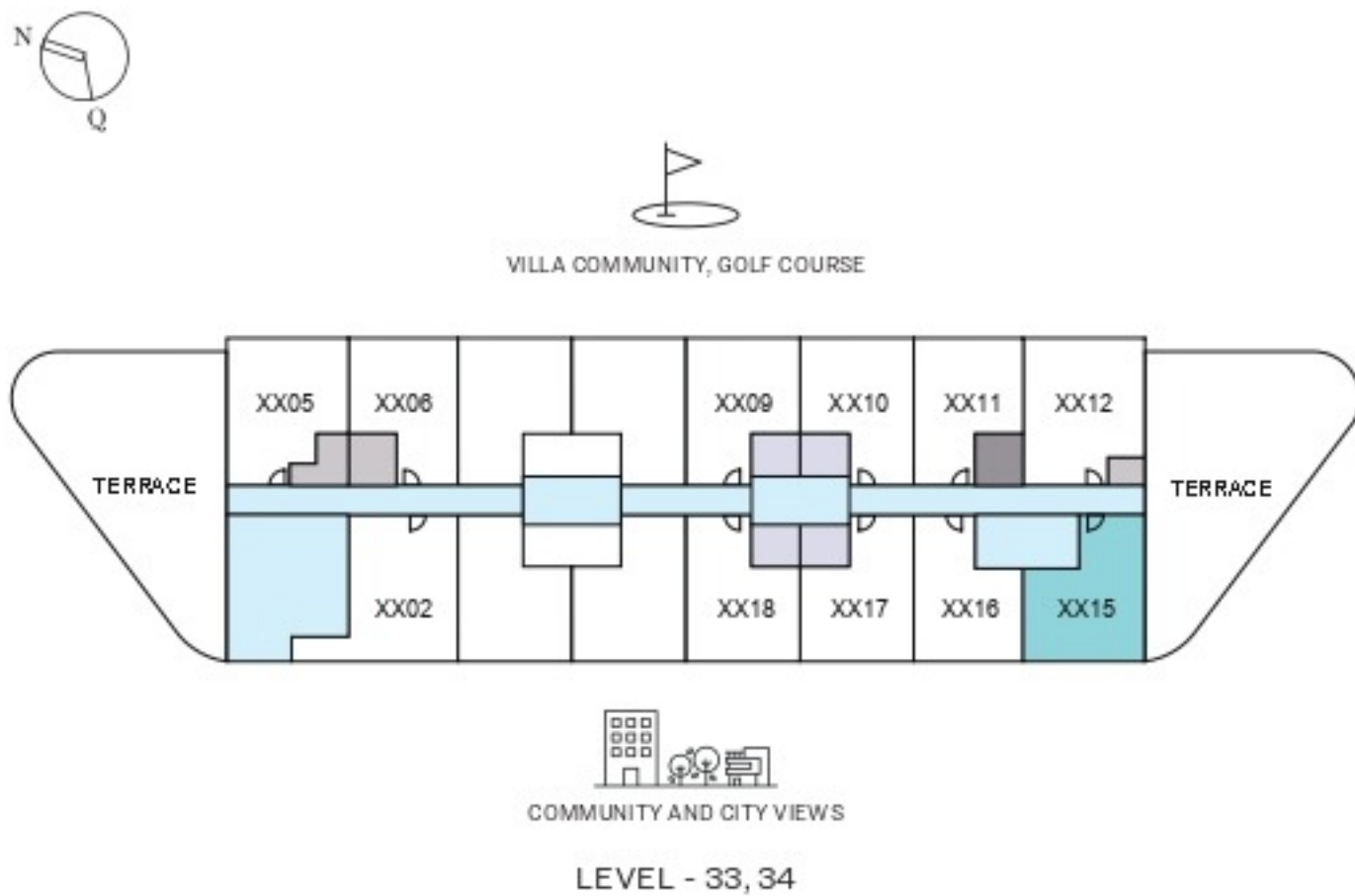
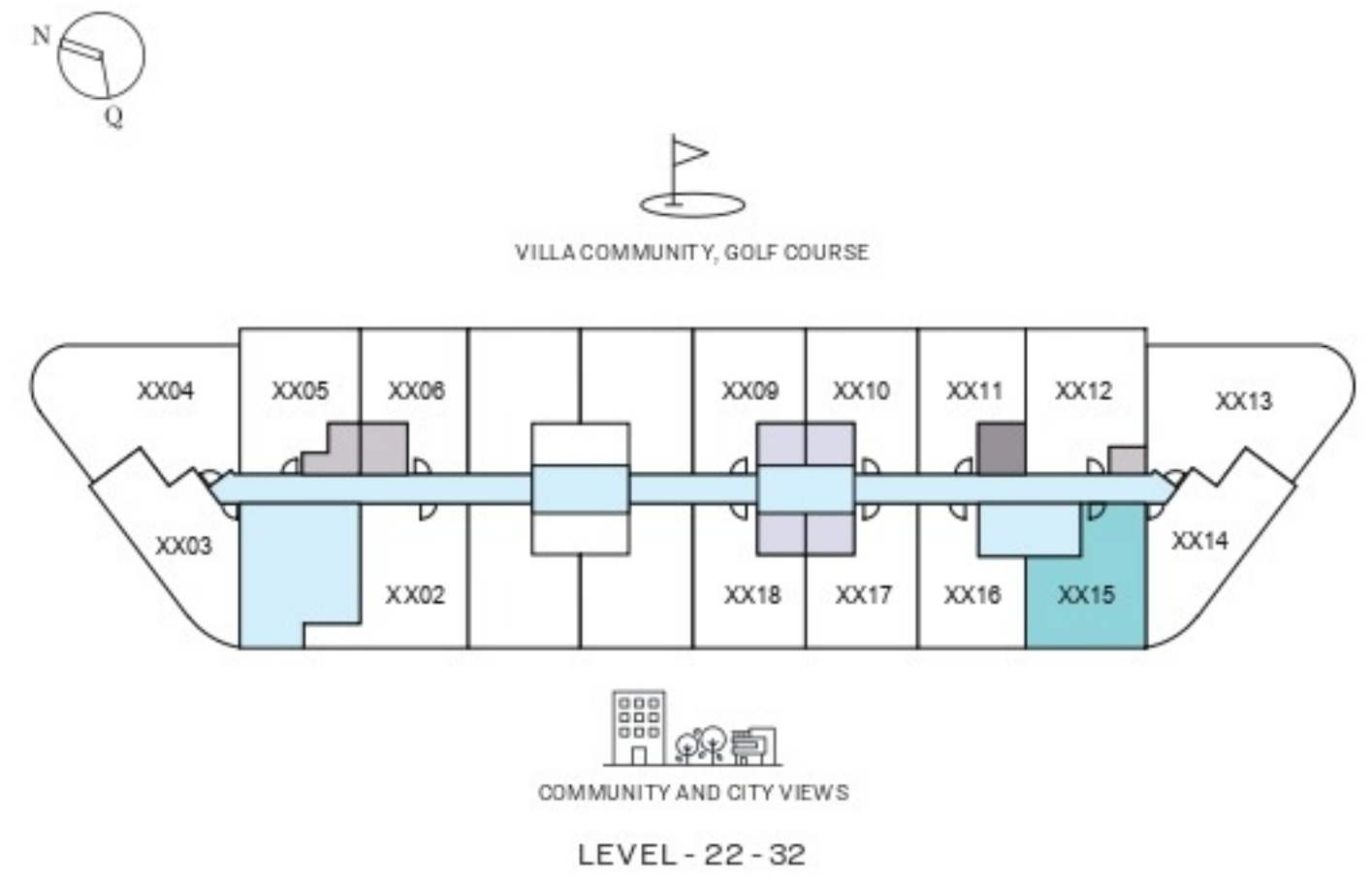
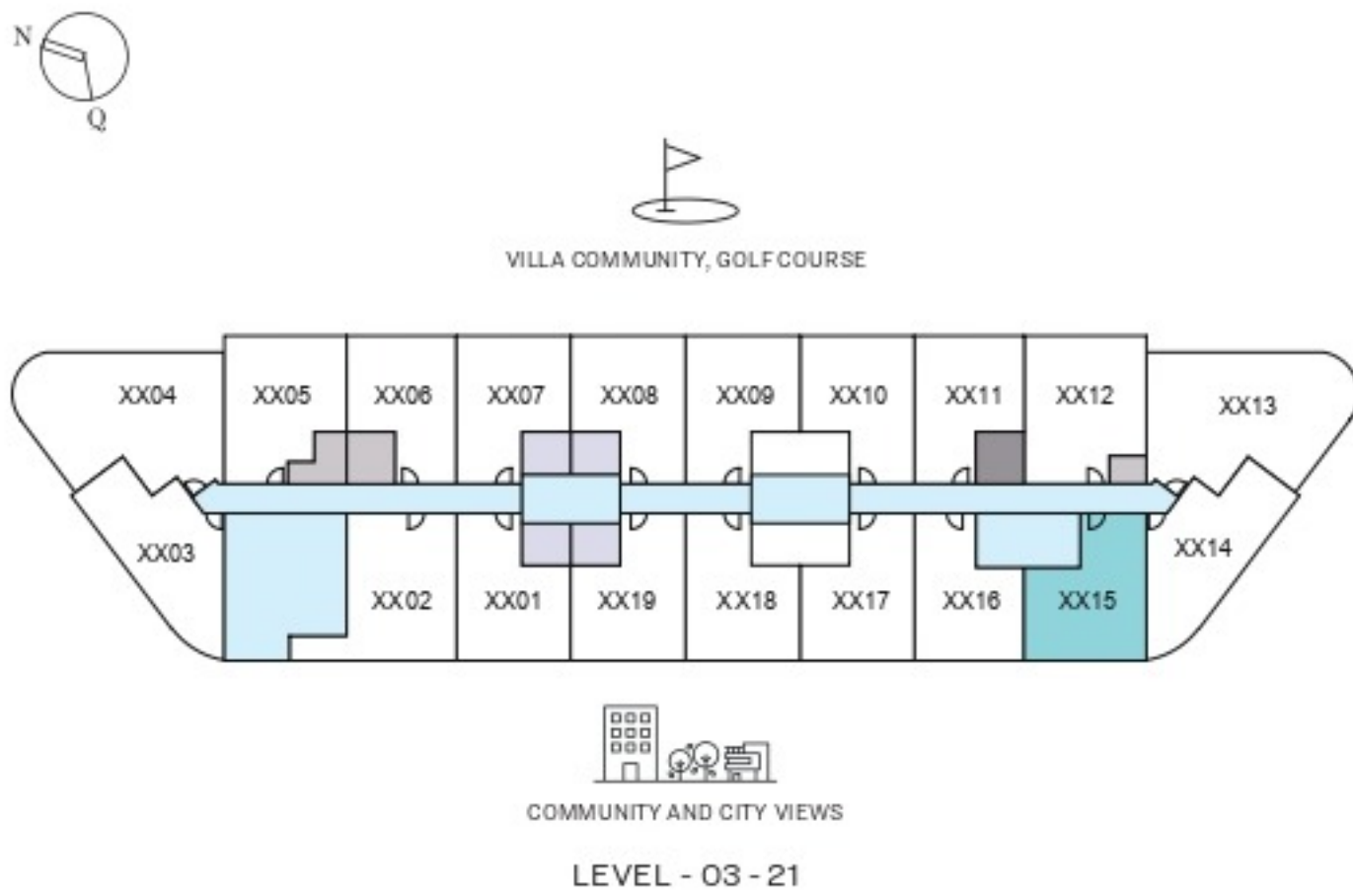

List of unit numbers with this unit plan:

VIEWS

Amenities

A315, A415, A515, A615, A715, A815, A915, A1015, A1115, A1215, A1315, A1415, A1515, A1615, A1715, A1815, A1915, A2015

Community, City View

A2115, A2215, A2315, A2415, A2515, A2615, A2715, A2815, A2915, A3015, A3115, A3215, A3315, A3415

Disclaimer: 1. All dimensions are in metric, measured to wall finishes. 2. All materials, dimensions & drawings are approximate. 3. Information is subject to change without notice, at developer's absolute discretion. 4. Actual area may vary from the stated area. 5. Drawing are not to scale. 6. All images used are for illustrative purpose only and do not represent the actual size, features, specifications, fittings and furnishings. 7. The developer reserves the right to make revisions/ alterations, at its absolute discretion, without any liability whatsoever.

1 BEDROOM APARTMENT

TYPE E (with balcony)

TOTAL SALEABLE AREA

SUITE = 485.56 SQ.FT.

BALCONY = 54.14 SQ.FT.

TOTAL = 539.70 SQ.FT.

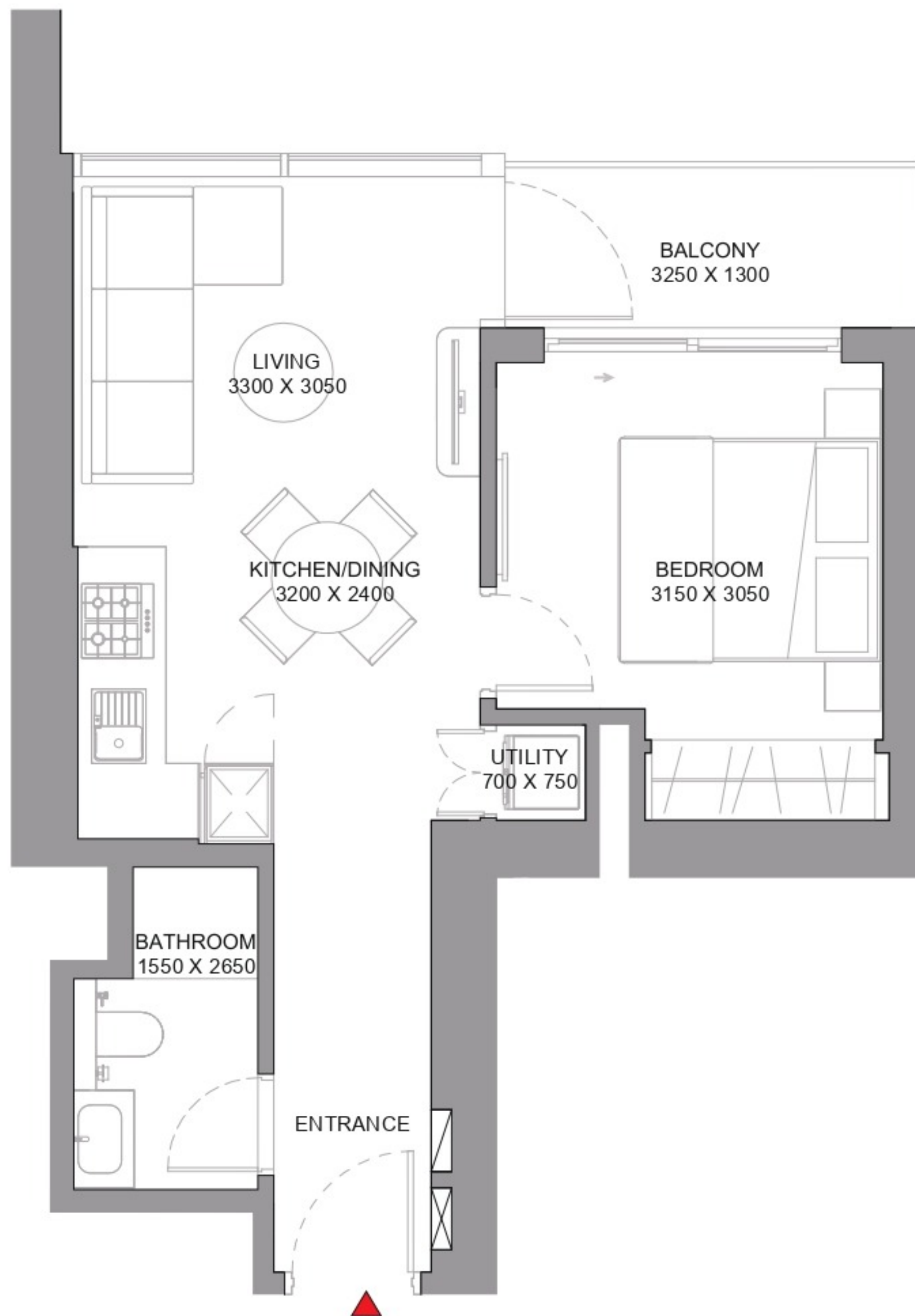

List of unit numbers with this unit plan:

VIEWS

Amenities

A315, A415, A515, A615, A715, A815, A915, A1015, A1115, A1215, A1315, A1415, A1515, A1615, A1715, A1815, A1915, A2015

Community, City View

A2115, A2215, A2315, A2415, A2515, A2615, A2715, A2815, A2915, A3015, A3115, A3215, A3315, A3415

Disclaimer: 1. All dimensions are in metric, measured to wall finishes. 2. All materials, dimensions & drawings are approximate. 3. Information is subject to change without notice, at developer's absolute discretion. 4. Actual area may vary from the stated area. 5. Drawing are not to scale. 6. All images used are for illustrative purpose only and do not represent the actual size, features, specifications, fittings and furnishings. 7. The developer reserves the right to make revisions/ alterations, at its absolute discretion, without any liability whatsoever.



1.5 BEDROOM APARTMENT

TYPE A (with study room + balcony)

TOTAL SALEABLE AREA

SUITE = 609.02 SQ.FT.

BALCONY = 61.78 SQ.FT.

TOTAL = 670.80 SQ.FT.

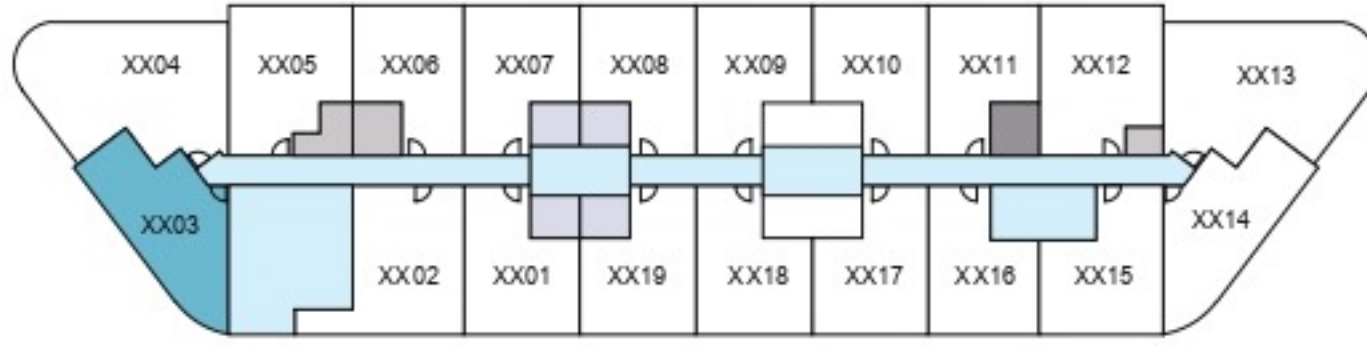

LEVEL - 03 - 21

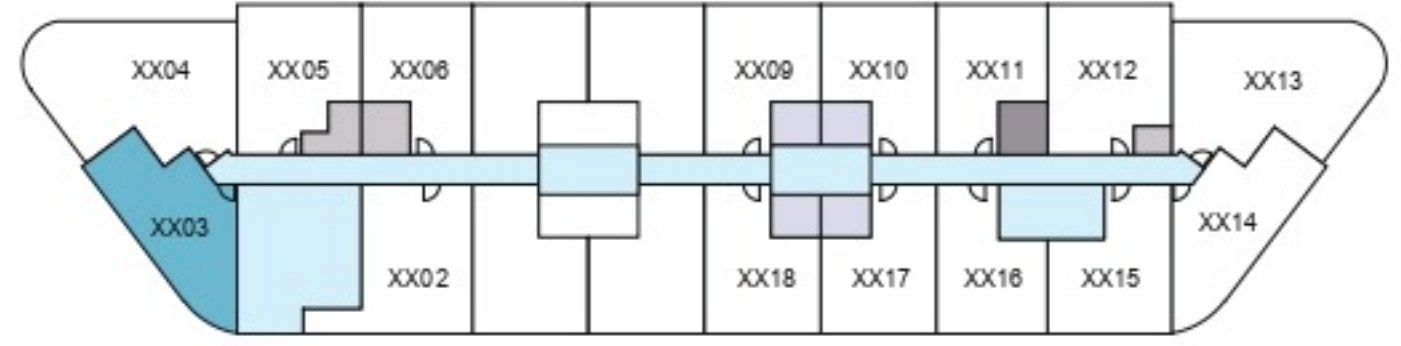
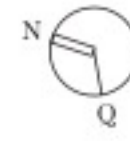

LEVEL - 22 - 32

UNIT

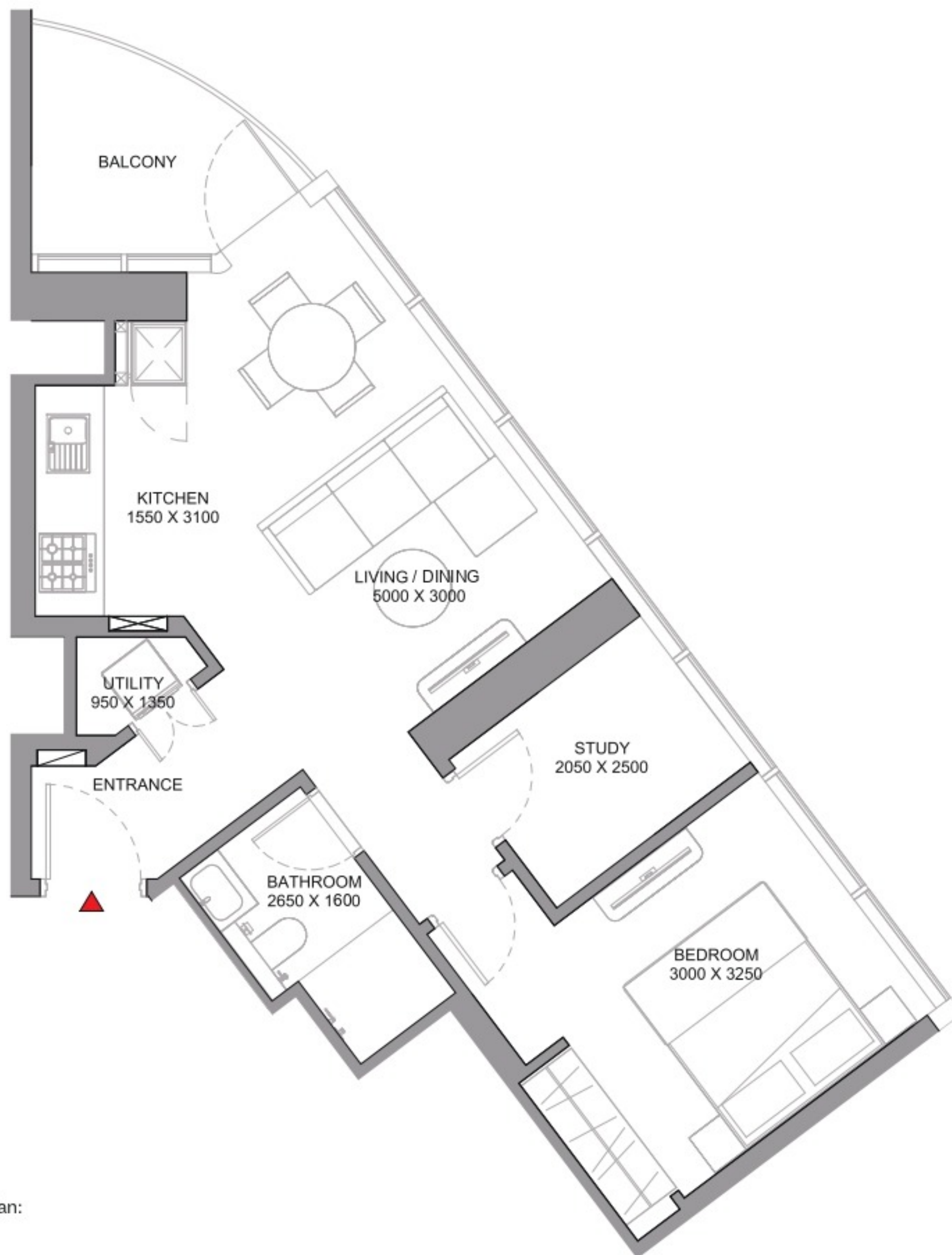

List of unit numbers with this unit plan:

VIEWS

Street View

A303, A403

Community, City View

A503, A603, A703, A803, A903, A1003, A1103, A1203, A1303, A1403, A1503, A1603, A1703, A1803, A1903, A2003, A2103, A2203, A2303, A2403, A2503, A2603, A2703, A2803, A2903, A3003, A3103, A3203

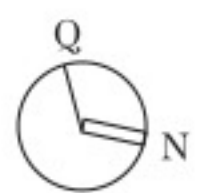

1.5 BEDROOM APARTMENT

TYPE B (with study room + balcony)

TOTAL SALEABLE AREA

SUITE = 605.25 SQ.FT.

BALCONY = 61.78 SQ.FT.

TOTAL = 667.03 SQ.FT.

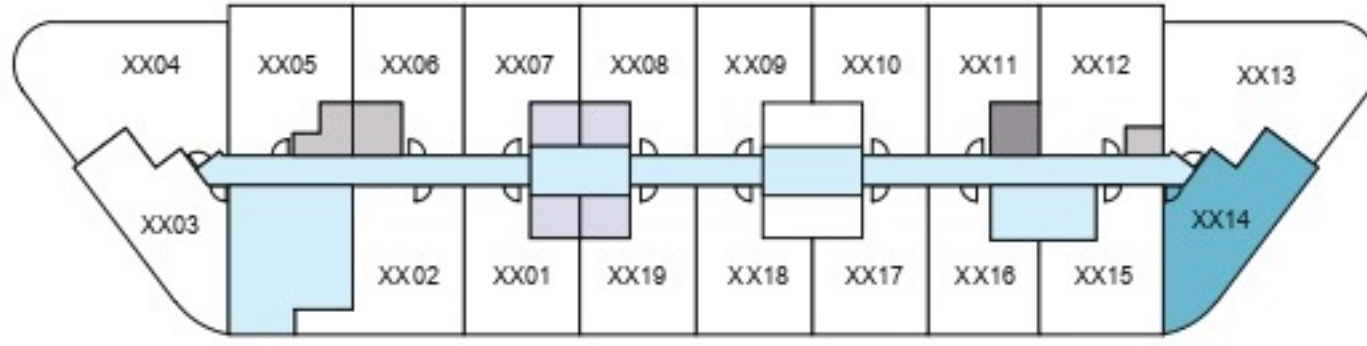
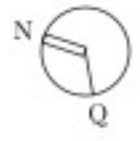

LEVEL - 03 - 21

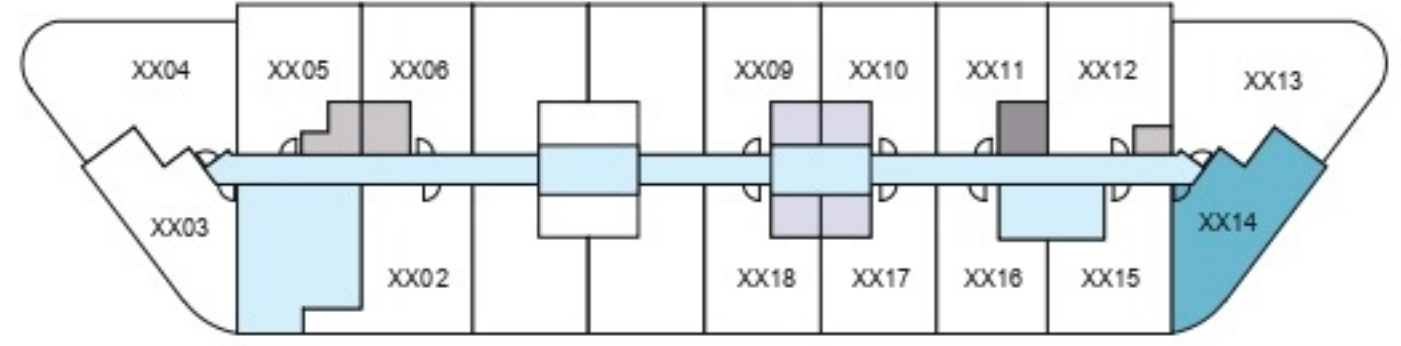
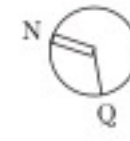

LEVEL - 22 - 32

UNIT

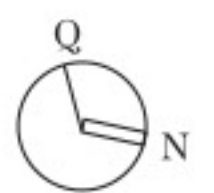
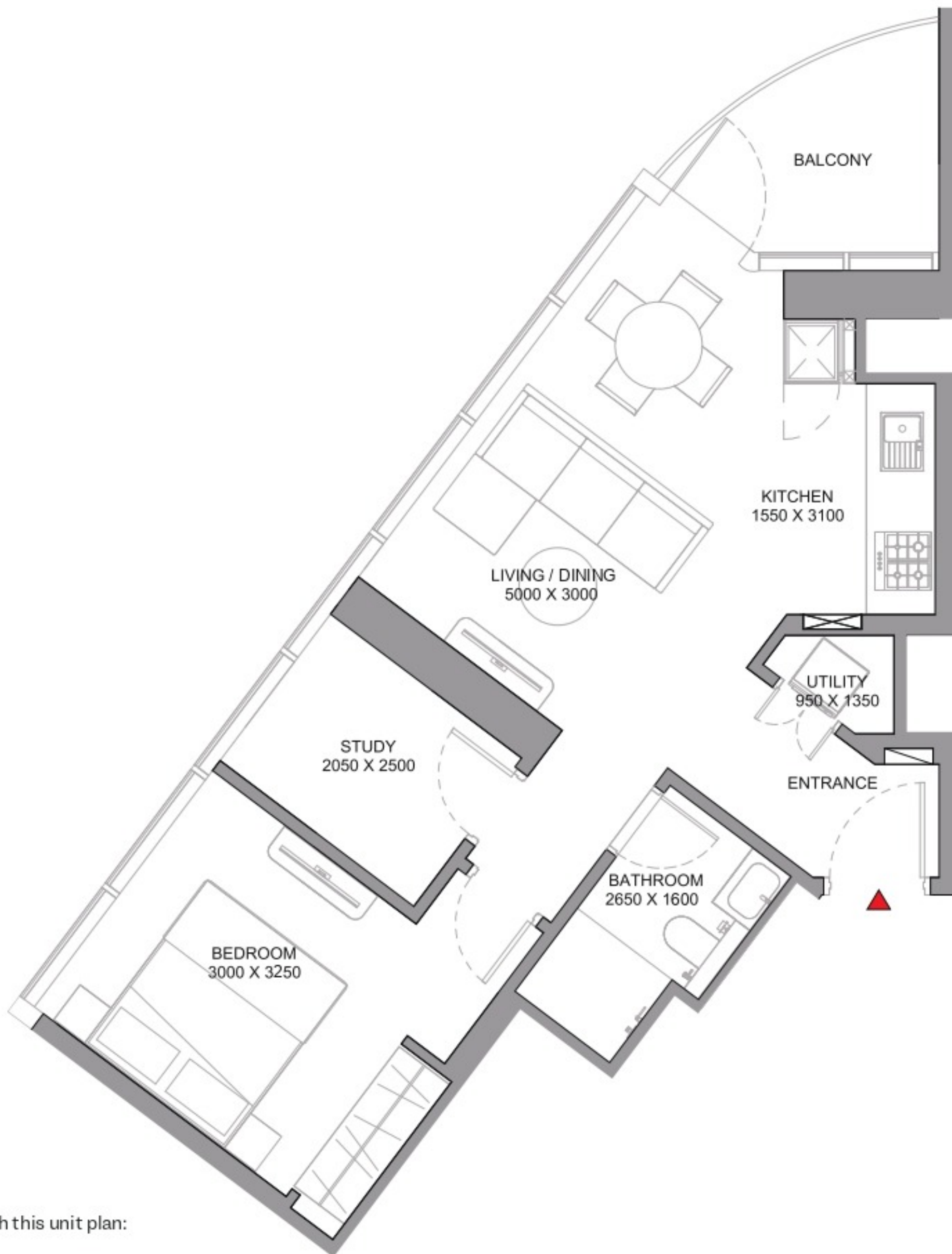

List of unit numbers with this unit plan:

VIEWS

Amenities

A314, A414, A514, A614, A714, A814, A914, A1014, A1114, A1214, A1314, A1414, A1514, A1614, A1714, A1814, A1914, A2014

Community, City View

A2114, A2214, A2314, A2414, A2514, A2614, A2714, A2814, A2914, A3014, A3114, A3214

Disclaimer: 1. All dimensions are in metric, measured to wall finishes. 2. All materials, dimensions & drawings are approximate. 3. Information is subject to change without notice, at developer's absolute discretion. 4. Actual area may vary from the stated area. 5. Drawing are not to scale. 6. All images used are for illustrative purpose only and do not represent the actual size, features, specifications, fittings and furnishings. 7. The developer reserves the right to make revisions/ alterations, at its absolute discretion, without any liability whatsoever.

1.5 BEDROOM APARTMENT

TYPE C (with store/study room, powder room + balcony)

TOTAL SALEABLE AREA

SUITE = 597.40 SQ.FT.
BALCONY = 99.78 SQ.FT.
TOTAL = 697.18 SQ.FT.

 UNIT

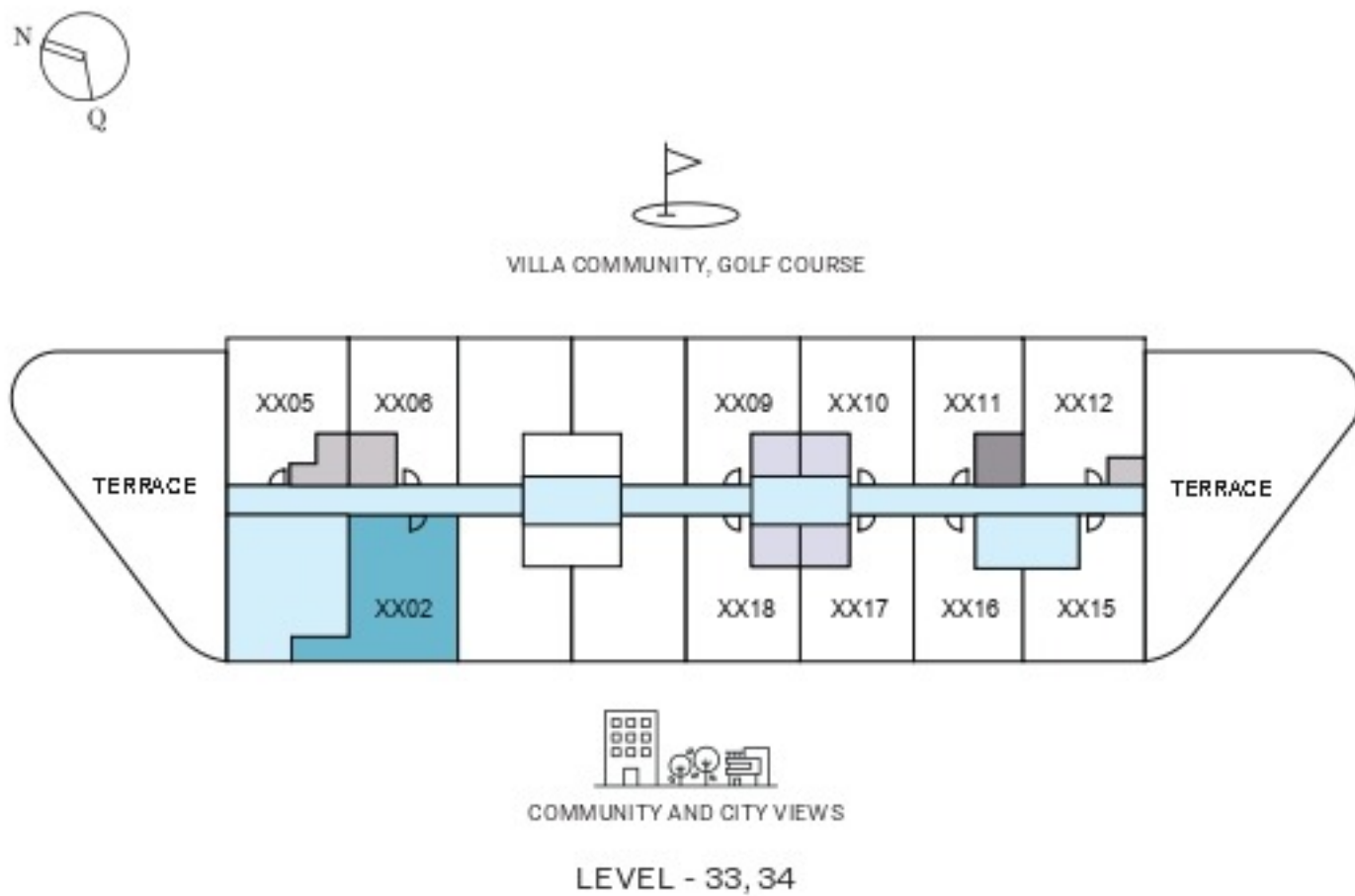
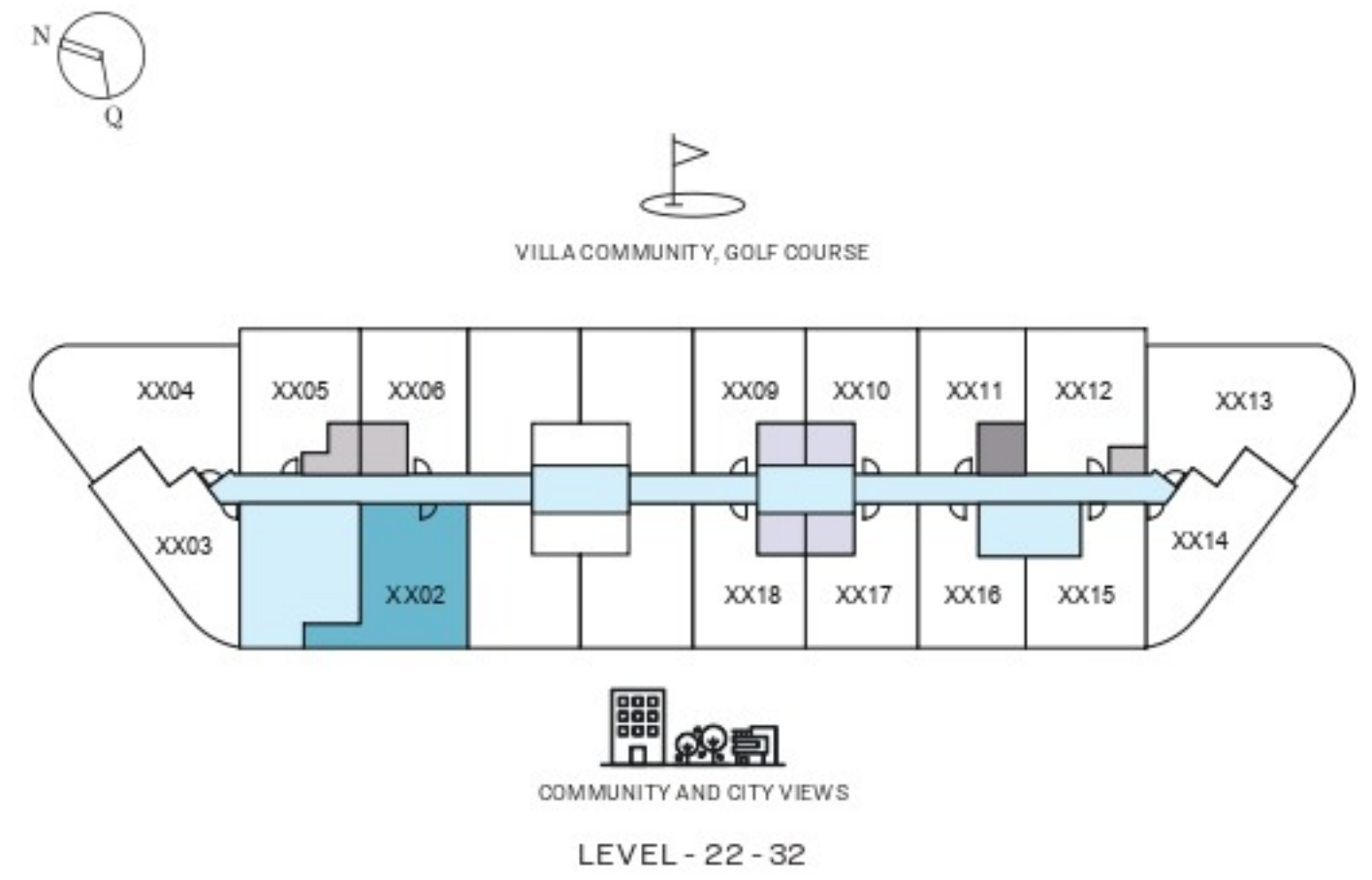
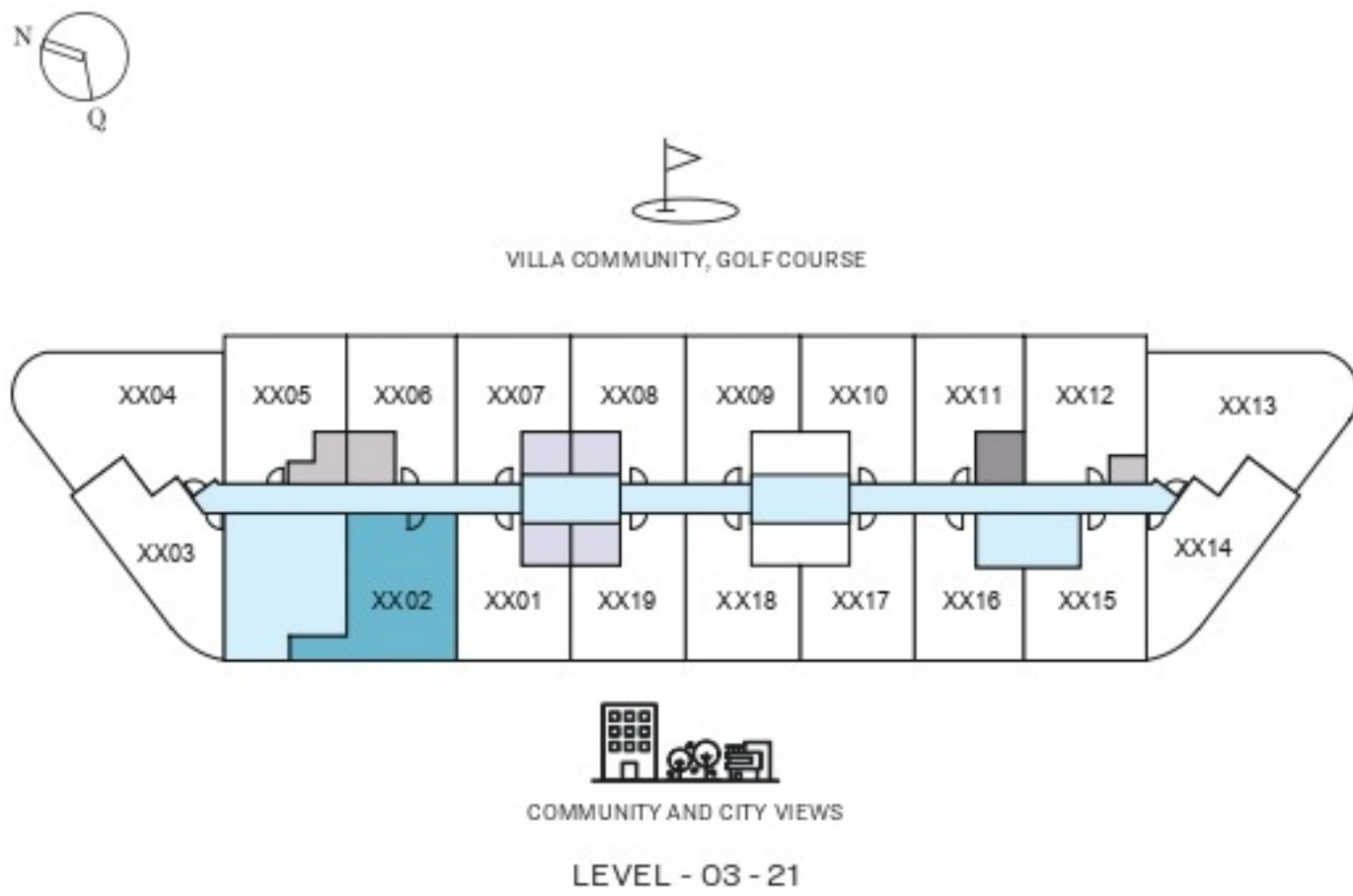

List of unit numbers with this unit plan:

VIEWS

Street View

A302, A402

Community, City View

A502, A602, A702, A802, A902, A1002, A1102, A1202, A1302, A1402, A1502, A1602, A1702, A1802, A1902, A2202, A2302, A2402, A2502, A2602, A2702, A2802, A2902, A3002, A3102, A3202, A3302, A3402

Disclaimer: 1. All dimensions are in metric, measured to wall finishes. 2. All materials, dimensions & drawings are approximate. 3. Information is subject to change without notice, at developer's absolute discretion. 4. Actual area may vary from the stated area. 5. Drawing are not to scale. 6. All images used are for illustrative purpose only and do not represent the actual size, features, specifications, fittings and furnishings. 7. The developer reserves the right to make revisions/ alterations, at its absolute discretion, without any liability whatsoever.

1.5 BEDROOM APARTMENT

TYPE C (with store/study room, powder room + balcony)

TOTAL SALEABLE AREA

SUITE = 597.40 SQ.FT.
BALCONY = 99.78 SQ.FT.
TOTAL = 697.18 SQ.FT.

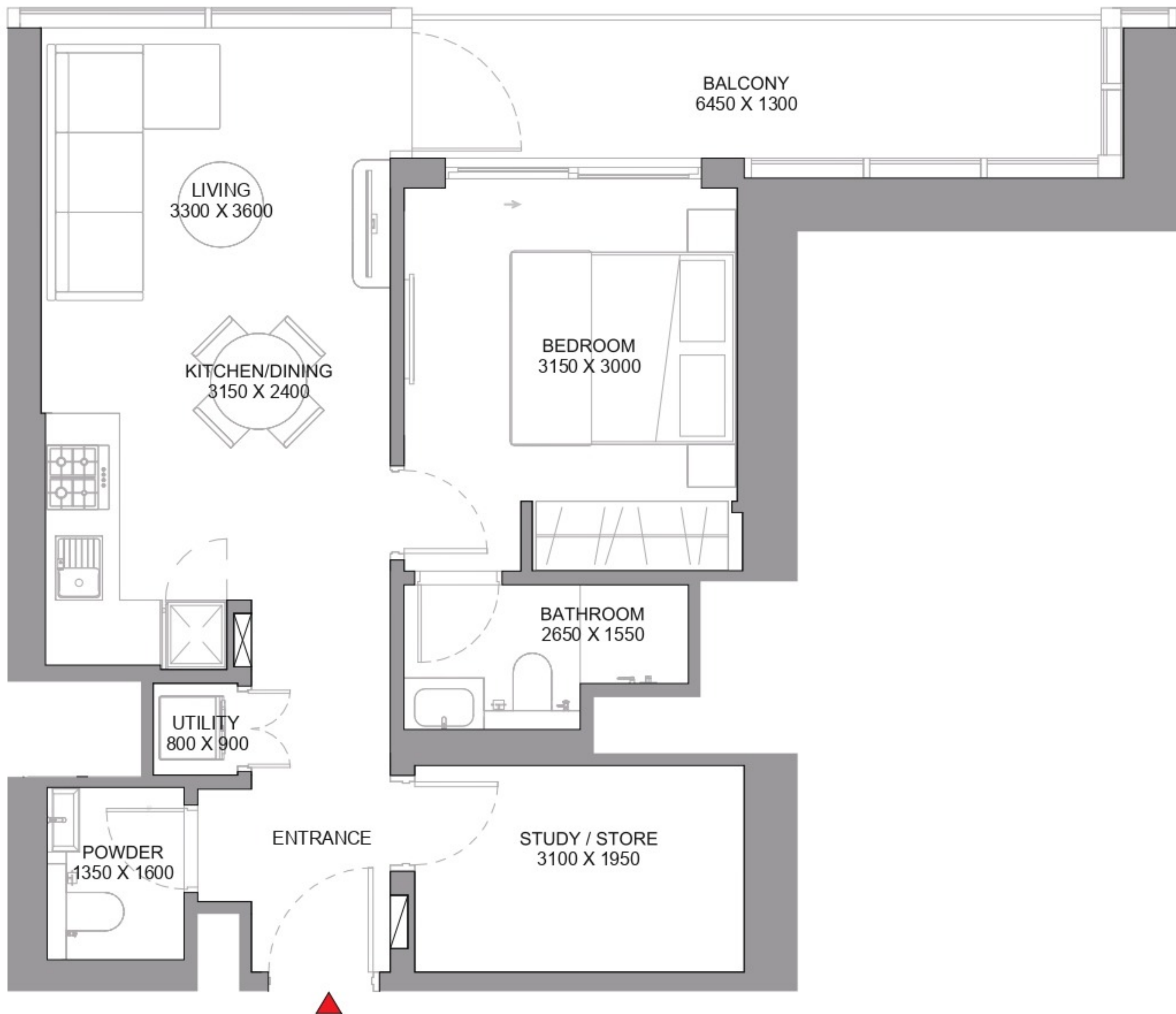

List of unit numbers with this unit plan:

VIEWS

Street View
A302, A402

Community, City View

A502, A602, A702, A802, A902, A1002, A1102, A1202, A1302, A1402, A1502, A1602, A1702, A1802, A1902, A2202, A2302, A2402, A2502, A2602, A2702, A2802, A2902, A3002, A3102, A3202, A3302, A3402

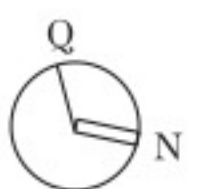

Disclaimer: 1. All dimensions are in metric, measured to wall finishes. 2. All materials, dimensions & drawings are approximate. 3. Information is subject to change without notice, at developer's absolute discretion. 4. Actual area may vary from the stated area. 5. Drawing are not to scale. 6. All images used are for illustrative purpose only and do not represent the actual size, features, specifications, fittings and furnishings. 7. The developer reserves the right to make revisions/ alterations, at its absolute discretion, without any liability whatsoever.

1.5 BEDROOM APARTMENT

TYPE D (with store/study room, powder room + balcony)

TOTAL SALEABLE AREA

SUITE = 567.47 SQ.FT.

BALCONY = 56.51 SQ.FT.

TOTAL = 623.98 SQ.FT.

 UNIT

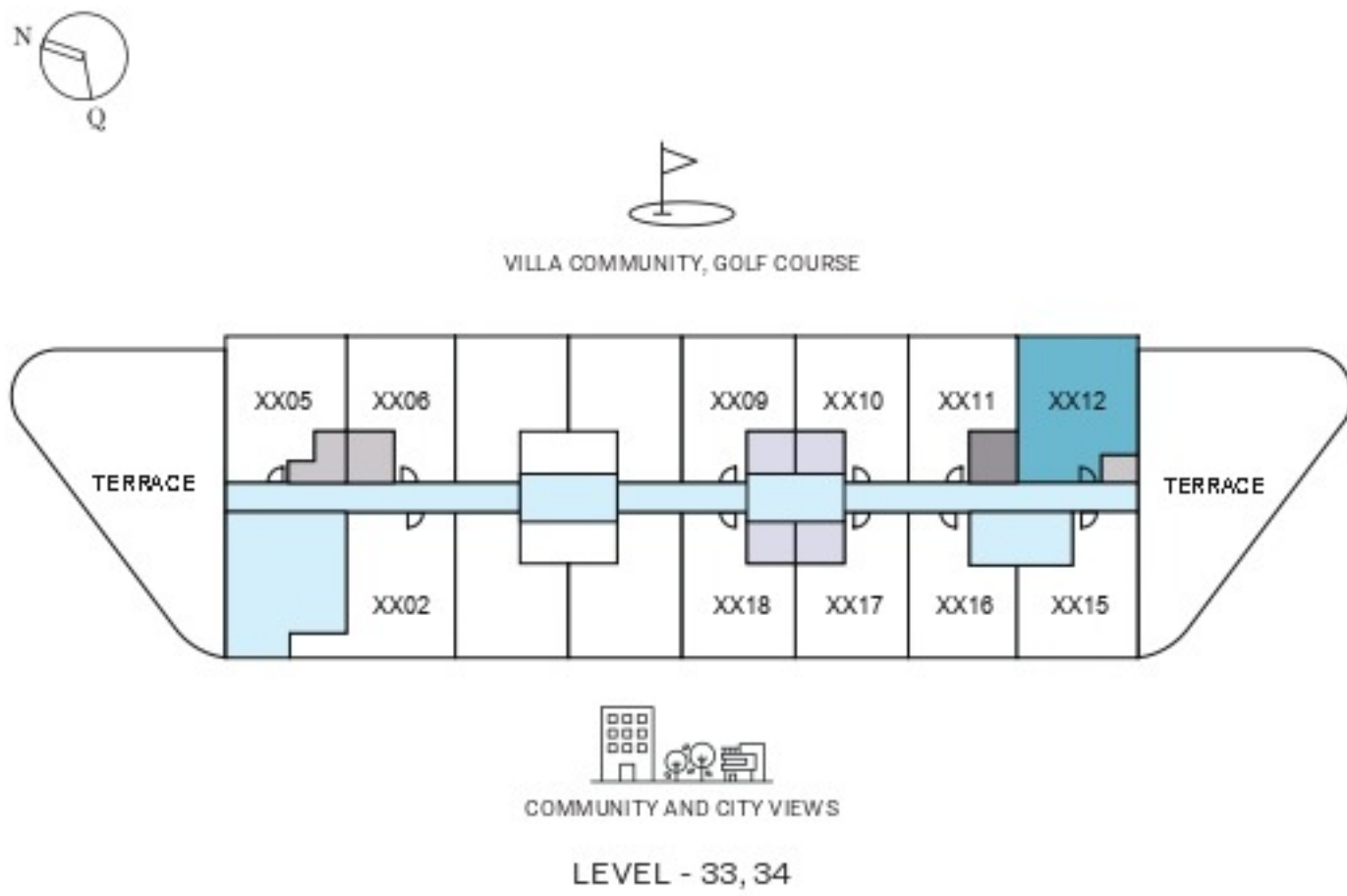

List of unit numbers with this unit plan:

VIEWS

Street View

A312, A412

Villa Community, Golf Course

A512, A612, A712, A812, A912, A1012, A1112, A1212, A1312, A1412, A1512, A1612, A1712, A1812, A1912, A2012, A2112, A2212, A2312, A2412, A2512, A2612, A2712, A2812, A2912, A3012, A3112, A3212, A3312, A3412

Disclaimer: 1. All dimensions are in metric, measured to wall finishes. 2. All materials, dimensions & drawings are approximate. 3. Information is subject to change without notice, at developer's absolute discretion. 4. Actual area may vary from the stated area. 5. Drawing are not to scale. 6. All images used are for illustrative purpose only and do not represent the actual size, features, specifications, fittings and furnishings. 7. The developer reserves the right to make revisions/ alterations, at its absolute discretion, without any liability whatsoever.

1.5 BEDROOM APARTMENT

TYPE D (with store/study room, powder room + balcony)

TOTAL SALEABLE AREA

SUITE = 567.47 SQ.FT.
 BALCONY = 56.51 SQ.FT.
 TOTAL = 623.98 SQ.FT.

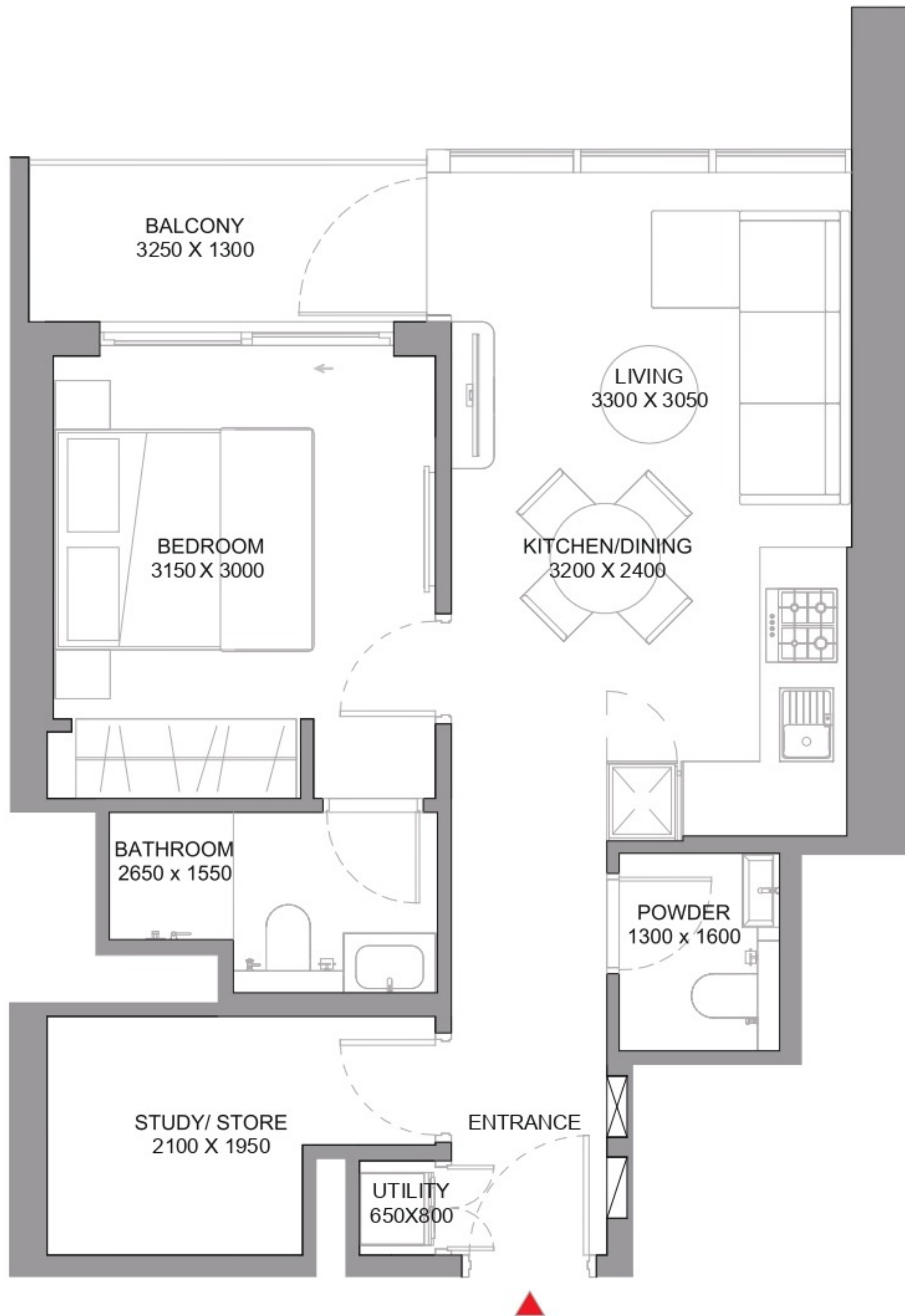

List of unit numbers with this unit plan:

VIEWS

Street View

A312, A412

Villa Community, Golf Course

A512, A612, A712, A812, A912, A1012, A1112, A1212, A1312, A1412, A1512, A1612, A1712, A1812, A1912, A2012, A2112, A2212, A2312, A2412, A2512, A2612, A2712, A2812, A2912, A3012, A3112, A3212, A3312, A3412

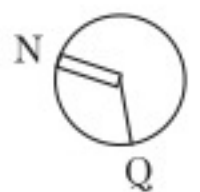

Disclaimer: 1. All dimensions are in metric, measured to wall finishes. 2. All materials, dimensions & drawings are approximate. 3. Information is subject to change without notice, at developer's absolute discretion. 4. Actual area may vary from the stated area. 5. Drawing are not to scale. 6. All images used are for illustrative purpose only and do not represent the actual size, features, specifications, fittings and furnishings. 7. The developer reserves the right to make revisions/ alterations, at its absolute discretion, without any liability whatsoever.

2 BEDROOM APARTMENT

TYPE A (with external shared powder + balcony)

TOTAL SALEABLE AREA

SUITE = 906.32 SQ.FT.
BALCONY = 78.15 SQ.FT.
TOTAL = 984.47 SQ.FT.

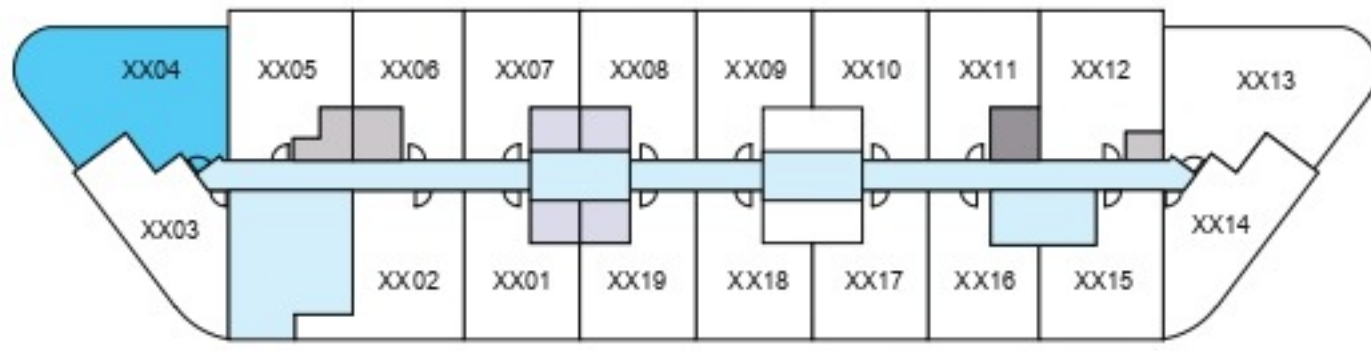

LEVEL - 03 - 21

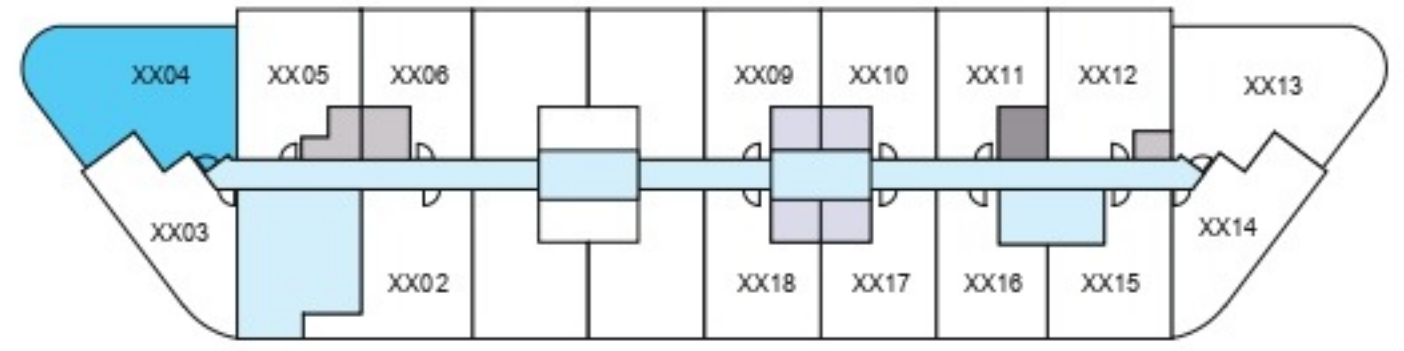
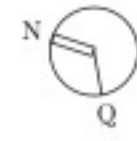

LEVEL - 22 - 32

UNIT

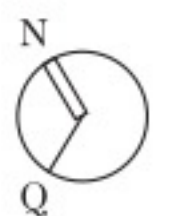
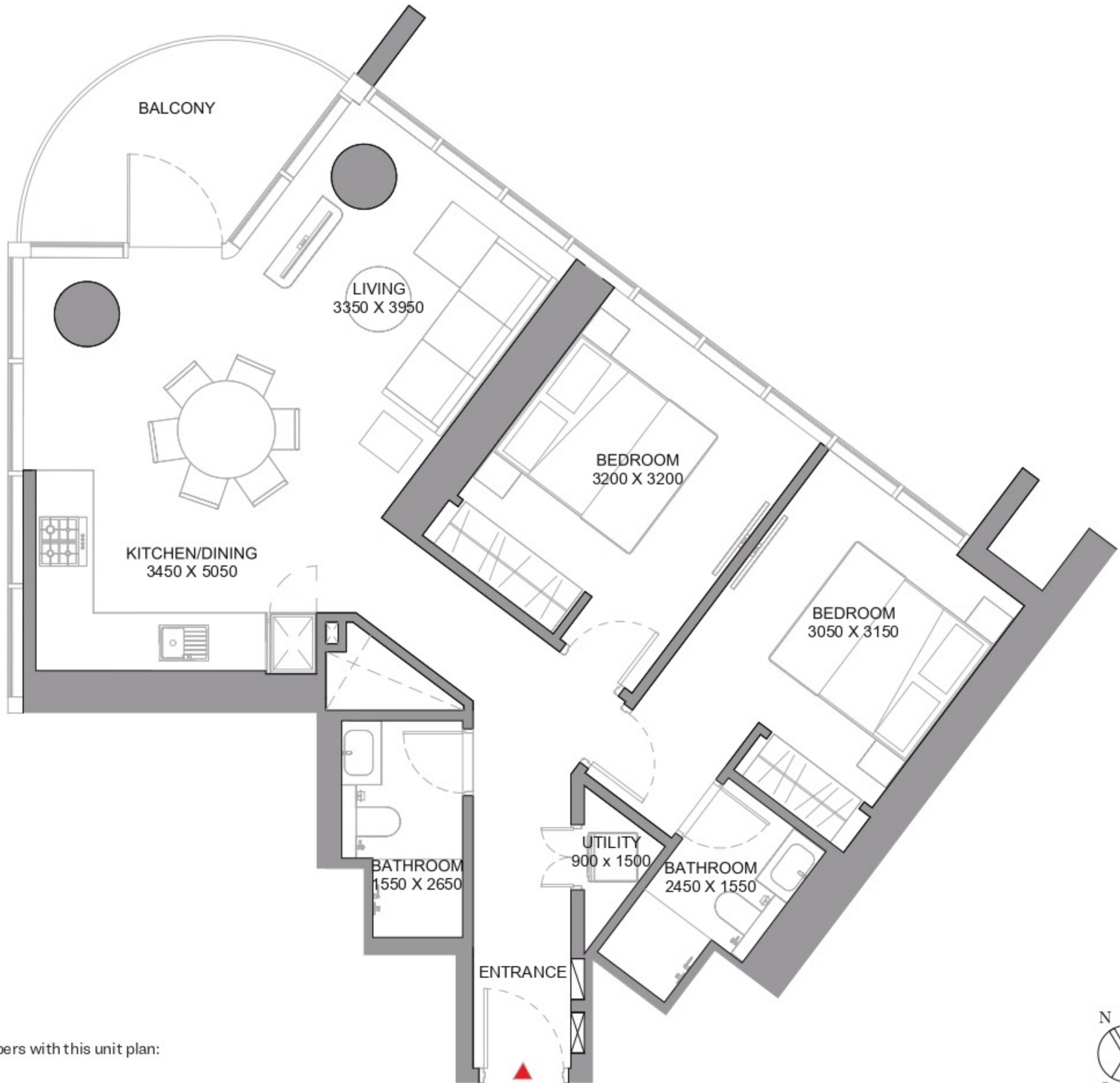

List of unit numbers with this unit plan:

VIEWS

Street View
A304, A404

180 degree views (City View, Miracle Garden, Villa Community, Golf Course)

A504, A604, A704, A804, A904, A1004, A1104, A1204, A1304, A1404, A1504, A1604, A1704, A1804, A1904, A2004, A2104, A2204, A2304, A2404, A2504, A2604, A2704, A2804, A2904, A3004, A3104, A3204

Disclaimer: 1. All dimensions are in metric, measured to wall finishes. 2. All materials, dimensions & drawings are approximate. 3. Information is subject to change without notice, at developer's absolute discretion. 4. Actual area may vary from the stated area. 5. Drawing are not to scale. 6. All images used are for illustrative purpose only and do not represent the actual size, features, specifications, fittings and furnishings. 7. The developer reserves the right to make revisions/ alterations, at its absolute discretion, without any liability whatsoever.

2 BEDROOM APARTMENT

TYPE B (with external shared powder + balcony)

TOTAL SALEABLE AREA

SUITE = 910.41 SQ.FT.
BALCONY = 78.04 SQ.FT.
TOTAL = 988.45 SQ.FT.

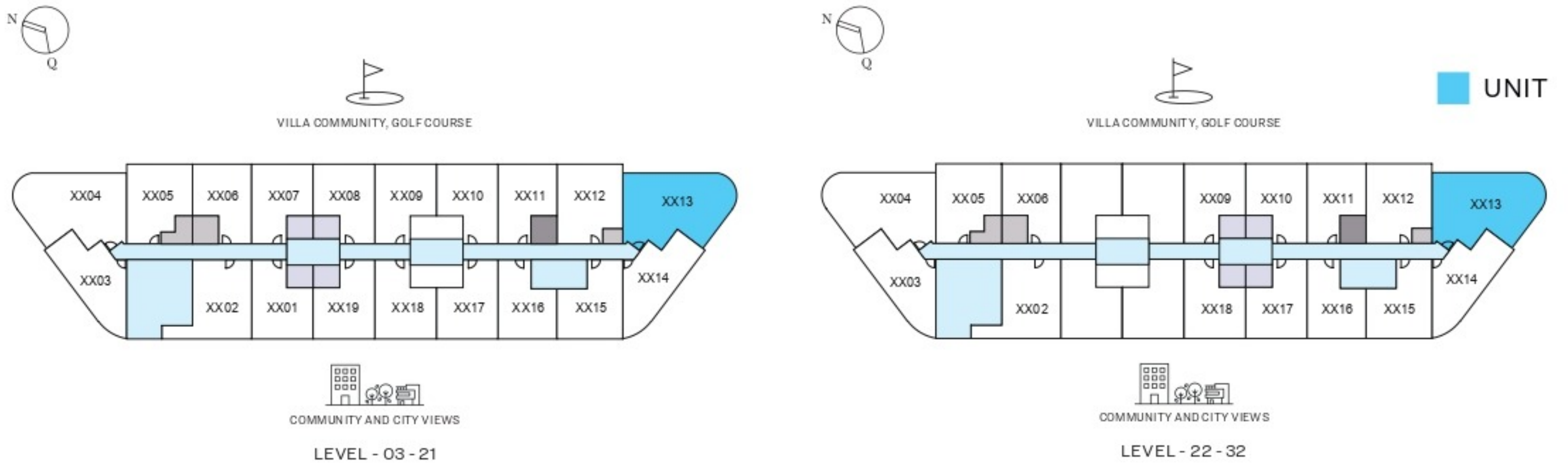

List of unit numbers with this unit plan:

VIEWS

Street View
A313, A413

180 degree views (Amenities, Community, Villa Community, Golf Course)

A513, A613, A713, A813, A913, A1013, A1113, A1213, A1313, A1413, A1513, A1613, A1713, A1813, A1913, A2013

180 degree views (Community, Villa Community, Golf Course)

A2113, A2213, A2313, A2413, A2513, A2613, A2713, A2813, A2913, A3013, A3113, A3213

Disclaimer: 1. All dimensions are in metric, measured to wall finishes. 2. All materials, dimensions & drawings are approximate. 3. Information is subject to change without notice, at developer's absolute discretion. 4. Actual area may vary from the stated area. 5. Drawing are not to scale. 6. All images used are for illustrative purpose only and do not represent the actual size, features, specifications, fittings and furnishings. 7. The developer reserves the right to make revisions/ alterations, at its absolute discretion, without any liability whatsoever.