

نور 3
استديو - نموذج B & C
NOOR 3
STUDIO APARTMENT - TYPE B & C

ST/B

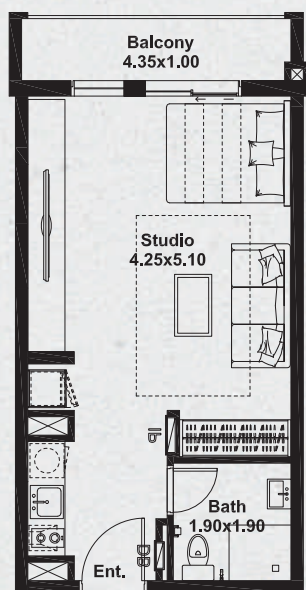

ST/C

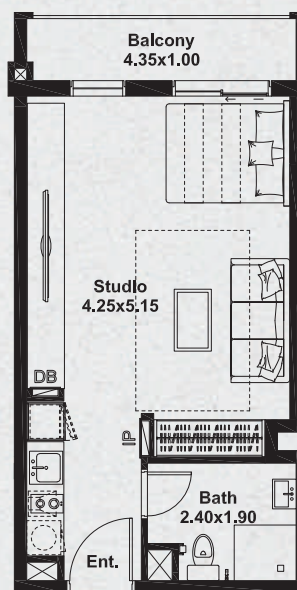

TYPE	LEVEL	UNIT (SQ.FT)	BALCONY (SQ.FT)	TOTAL (SQ.FT)
ST/B	9-16	380	56	436
ST/C	9-16	384	56	440

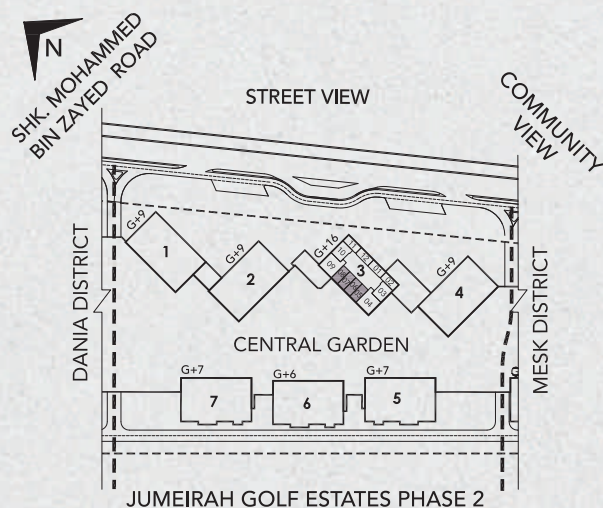

NOOR 3

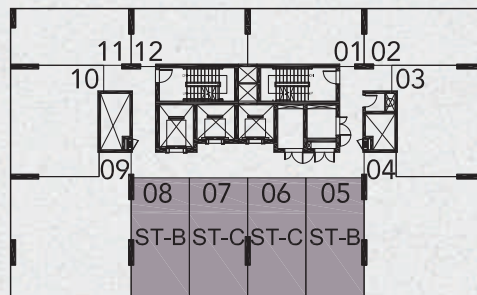

LEVEL 10-16

NOOR 3

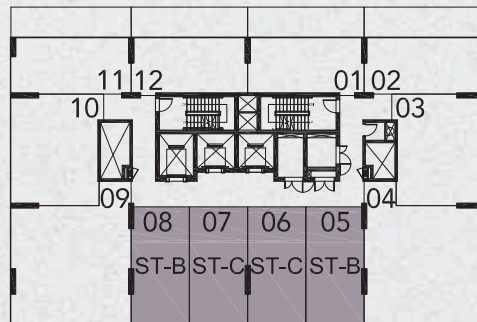

LEVEL 9

STUDIO - TYPE D & E

نور 3
استديو - نموذج D & E
NOOR 3
STUDIO APARTMENT - TYPE D & E

ST/D

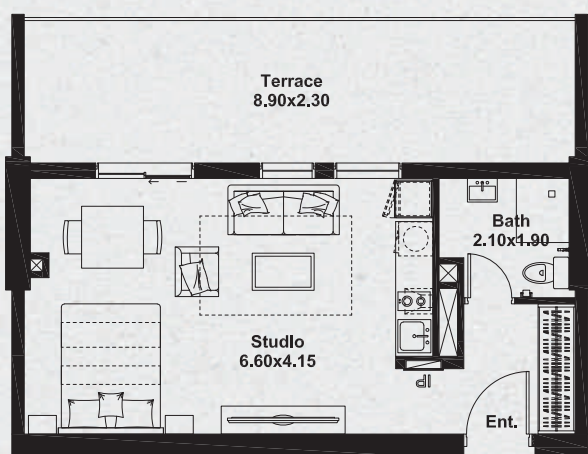

ST/E

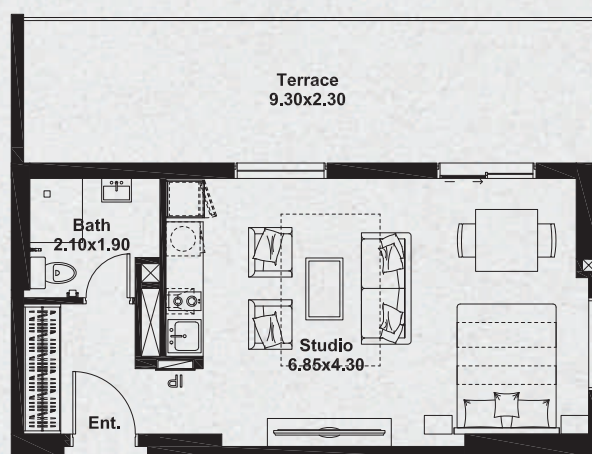

TYPE	LEVEL	UNIT (SQ.FT)	BALCONY (SQ.FT)	TOTAL (SQ.FT)
ST/D	9	427	240	667
ST/E	9	443	248	691

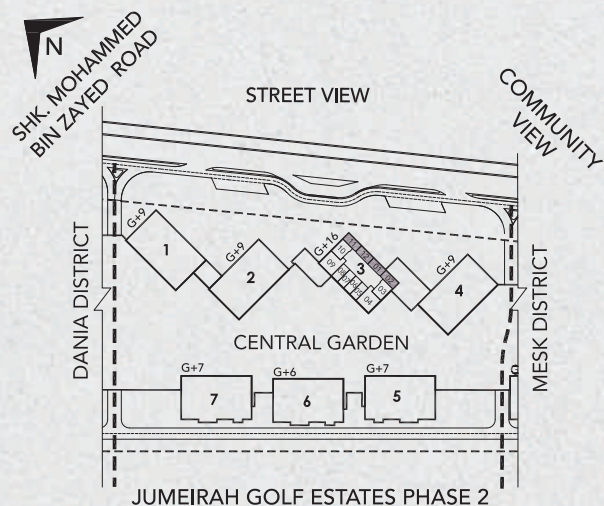

NOOR 3

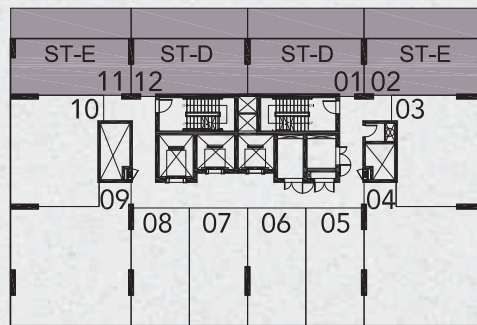

LEVEL 9

STUDIO - TYPE F & G

نور 3
 F & G - نموذج استديو
 NOOR 3
 STUDIO APARTMENT - TYPE F & G

ST/F

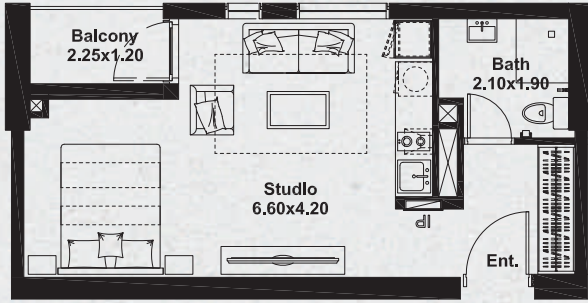

ST/G

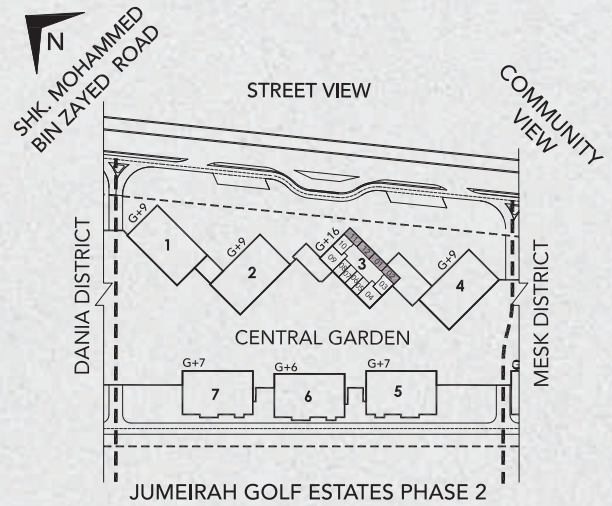
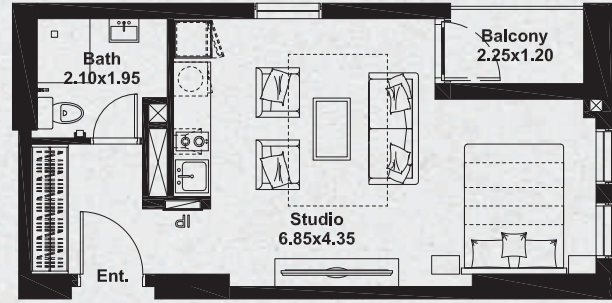

TYPE	LEVEL	UNIT (SQ.FT)	BALCONY (SQ.FT)	TOTAL (SQ.FT)
ST/F	10-16	394	37	431
ST/G	10-16	406	37	443

NOOR 3

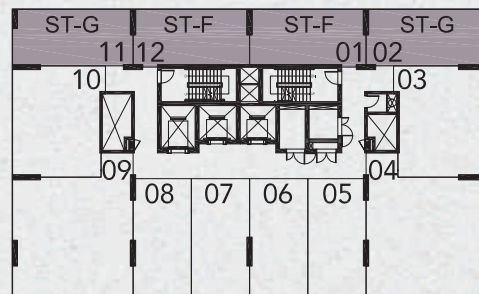

LEVEL 10-16

نور 1, 2, 3 & 4
 استديو - نموذج H
 NOOR 1, 2, 3 & 4
 STUDIO APARTMENT - TYPE H

ST/H

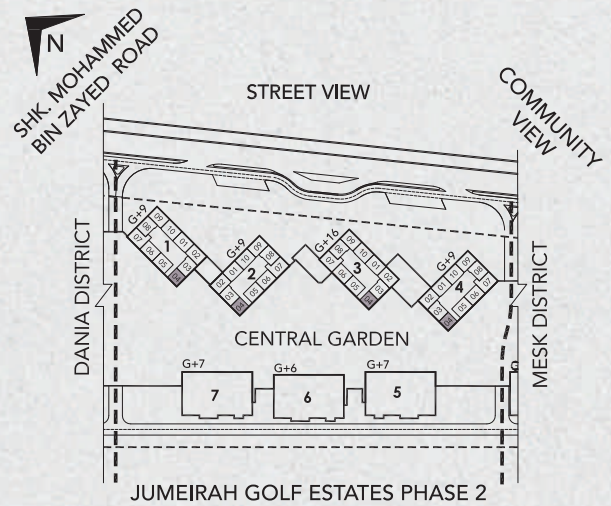
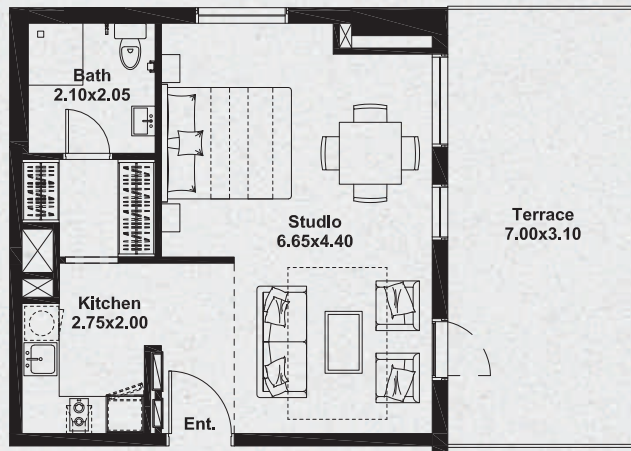

TYPE	LEVEL	UNIT (SQ.FT)	BALCONY (SQ.FT)	TOTAL (SQ.FT)
ST/H	1	486	246	732

NOOR 3

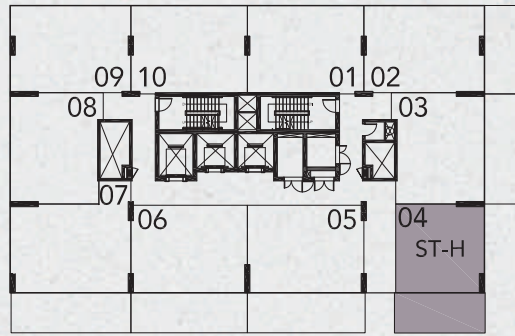

LEVEL 1

NOOR 2 & 4

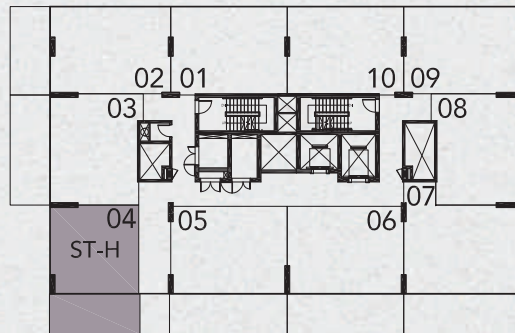

LEVEL 1

NOOR 1

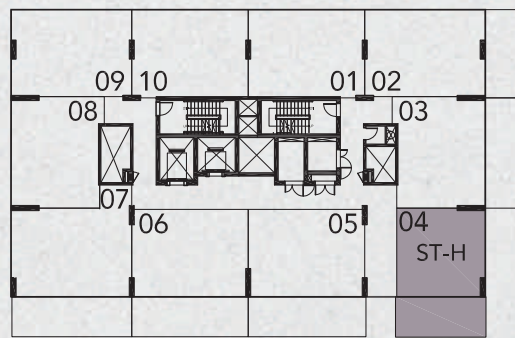

LEVEL 1

نور 1, 2, 3 & 4
شقة مكونة من غرفة نوم واحدة - نموذج A
NOOR 1, 2, 3 & 4
ONE BEDROOM APARTMENT - TYPE A

1BR/A

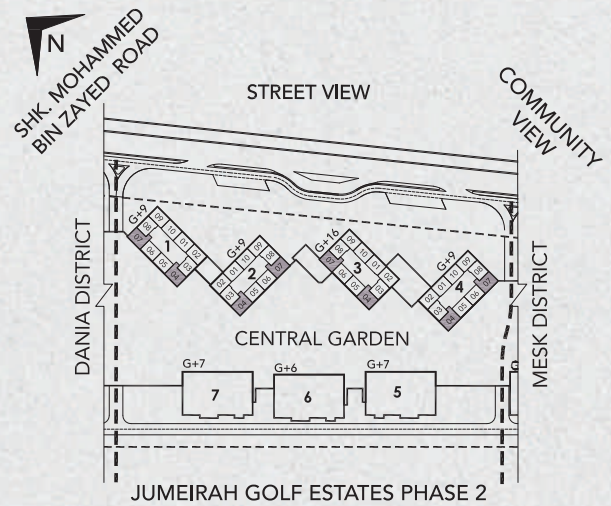
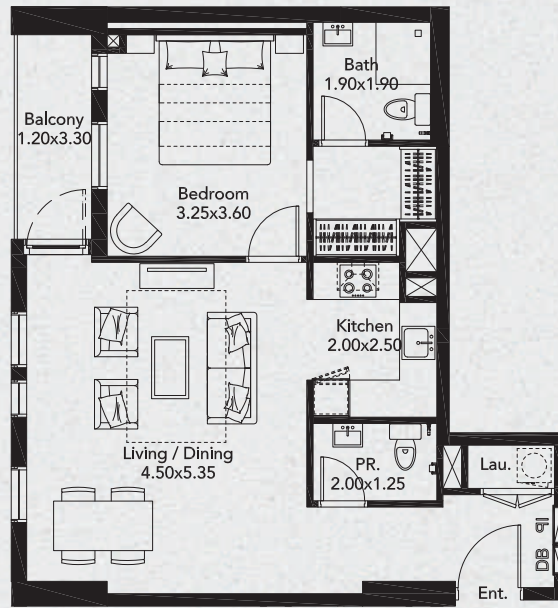

TYPE	LEVEL	UNIT (SQ.FT)	BALCONY (SQ.FT)	TOTAL (SQ.FT)
1BR/A	2-9	682	53	735

NOOR 3

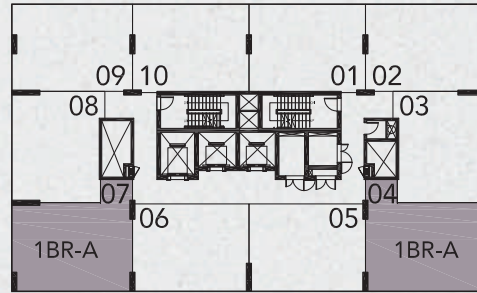

LEVEL 2-8

NOOR 2 & 4

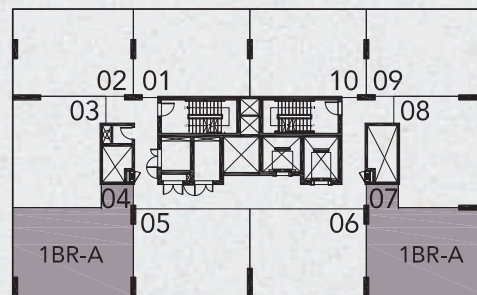

LEVEL 2-9

NOOR 1

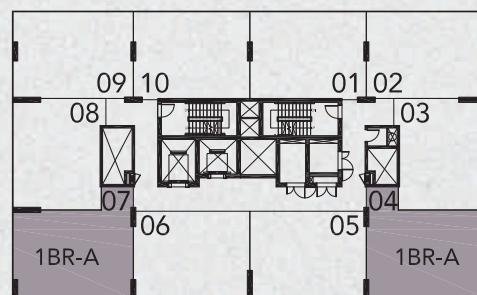

LEVEL 2-9

1BR - TYPE B

نور 1, 2, 3 & 4
شقة مكونة من غرفة نوم واحدة - نموذج B
NOOR 1, 2, 3 & 4
ONE BEDROOM APARTMENT - TYPE B

1BR/B

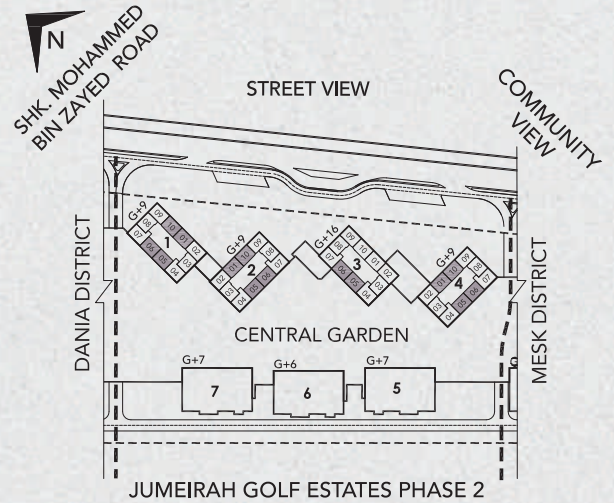
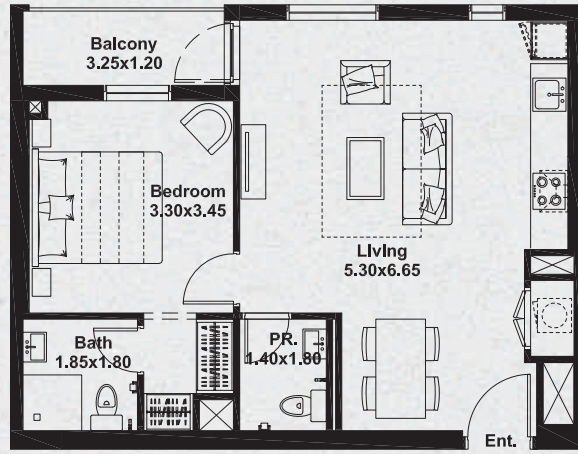

TYPE	LEVEL	UNIT (SQ.FT)	BALCONY (SQ.FT)	TOTAL (SQ.FT)
1BR/B	1-9	607	51	658
	2-9	586	51	637

NOOR 2 & 4

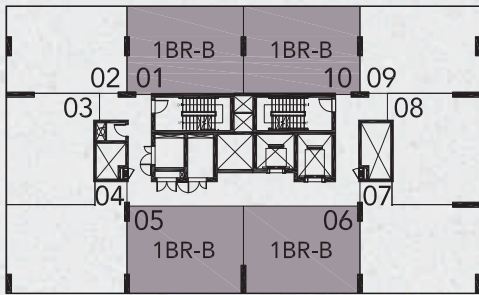

LEVEL 2-9

NOOR 2 & 4

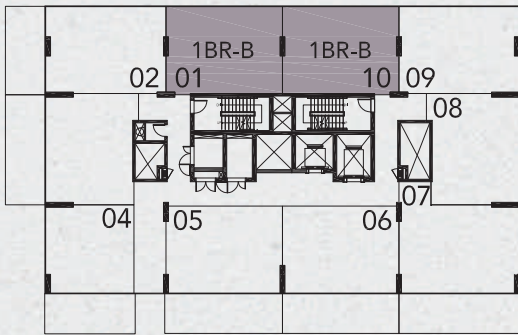

LEVEL 1

NOOR 1

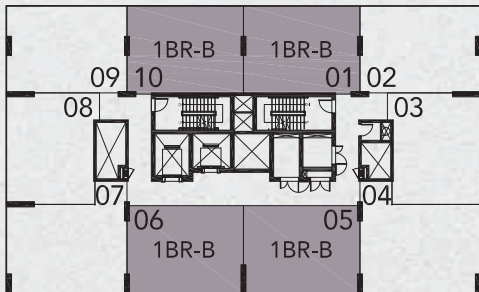

LEVEL 2-9

NOOR 1

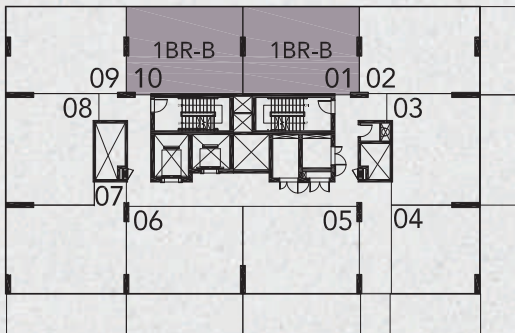

LEVEL 1

NOOR 3

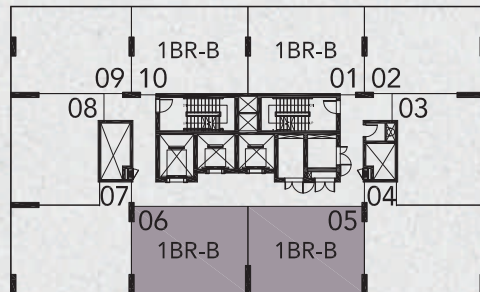

LEVEL 2-8

1BR - TYPE B*

نور 3

شقة مكونة من غرفة نوم واحدة - نموذج *B

NOOR 3

ONE BEDROOM APARTMENT - TYPE B*

1BR/B*

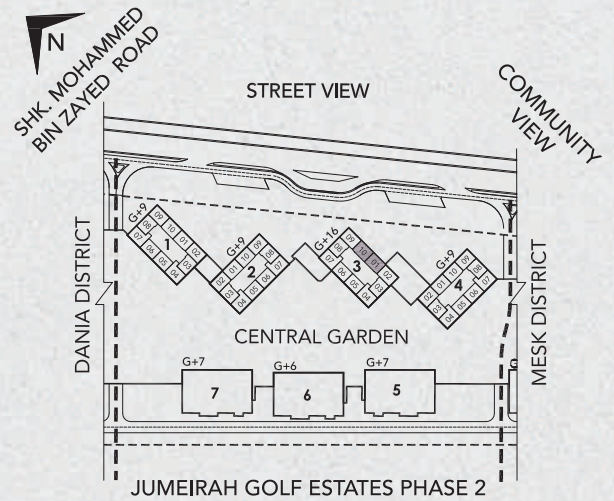
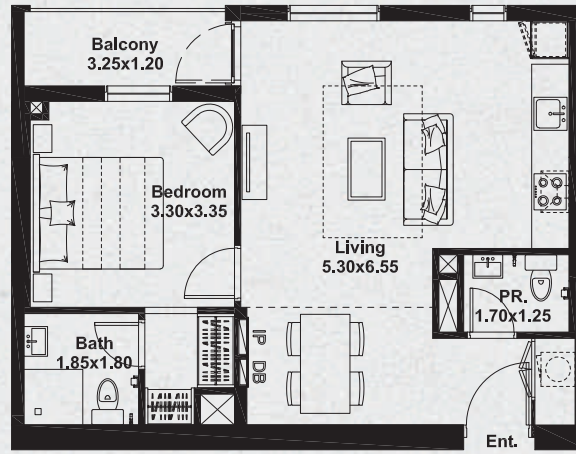

TYPE	LEVEL	UNIT (SQ.FT)	BALCONY (SQ.FT)	TOTAL (SQ.FT)
1BR/B*	1-8	610	51	661

إن جميع الصور والمخططات والتصاميم والمعلومات والبيانات التفصيل الواردة في هذا الكتيب هي إرشادية فقط وقد تتغير في أي وقت حسب التصاميم النهائية للمشروع والموافقات التنظيمية وتصاريح التخطيط.

All pictures, plans, layouts, information, data and details included in this brochure are indicative only and may change at any time in accordance with the final designs of the project, regulatory approvals and planning permissions.

NOOR 3

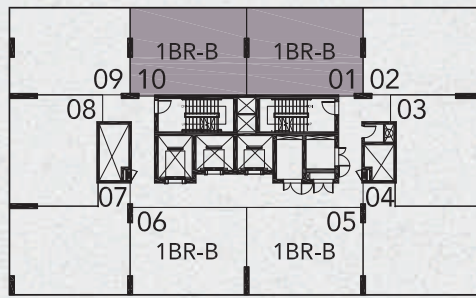

LEVEL 2-8

NOOR 3

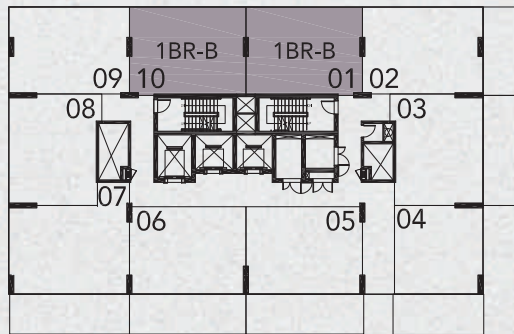

LEVEL 1

نور 1, 2, 3 & 4
شقة مكونة من غرفة نوم واحدة - نموذج C
NOOR 1, 2, 3 & 4
ONE BEDROOM APARTMENT - TYPE C

1BR/C

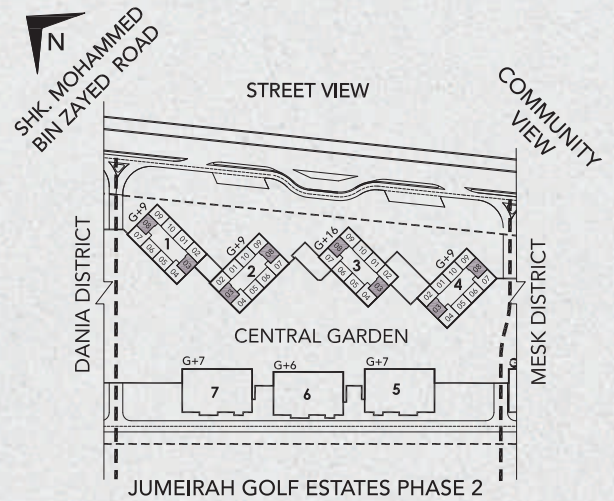
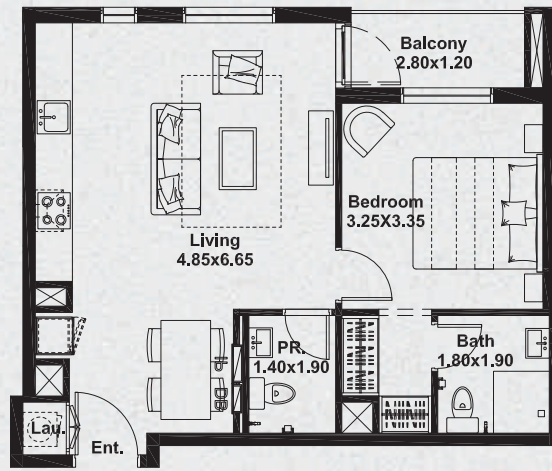

TYPE	LEVEL	UNIT (SQ.FT)	BALCONY (SQ.FT)	TOTAL (SQ.FT)
1BR/C	1-16	578	43	621

NOOR 2 & 4

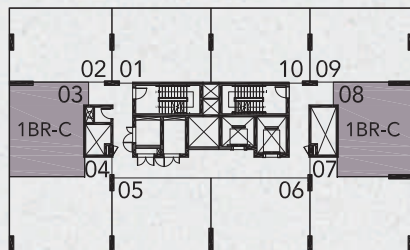

LEVEL 2-9

NOOR 3

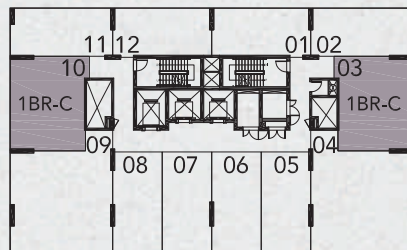

LEVEL 10-16

NOOR 2 & 4

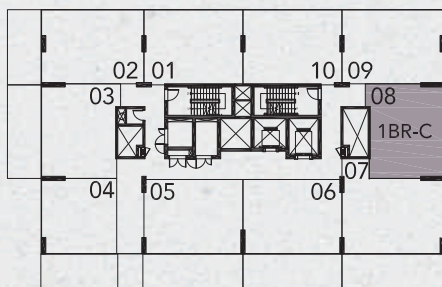

LEVEL 1

NOOR 3

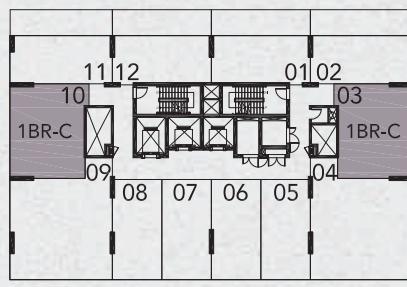

LEVEL 9

NOOR 1

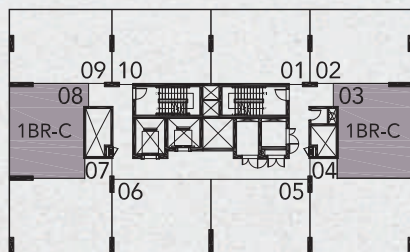

LEVEL 2-9

NOOR 3

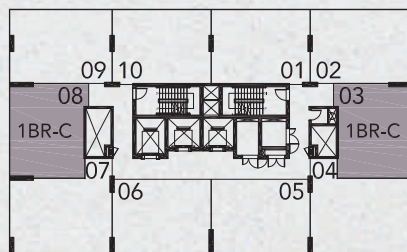

LEVEL 2-8

NOOR 1

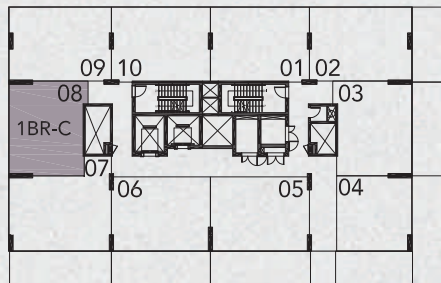

LEVEL 1

NOOR 3

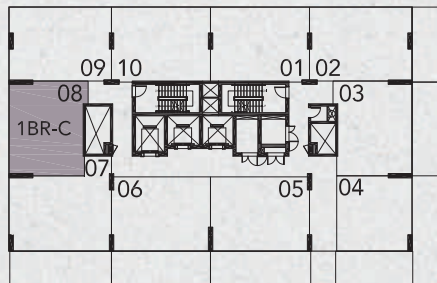

LEVEL 1

نور 1, 2, 3 & 4
شقة مكونة من غرفة نوم واحدة - نموذج C1
NOOR 1, 2, 3 & 4
ONE BEDROOM APARTMENT - TYPE C1

1BR/C1

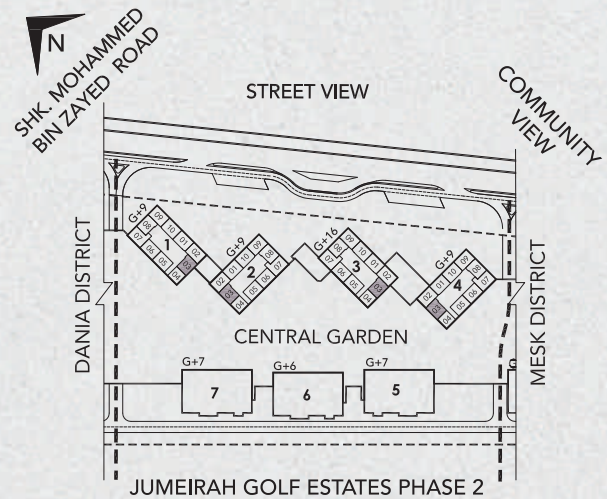
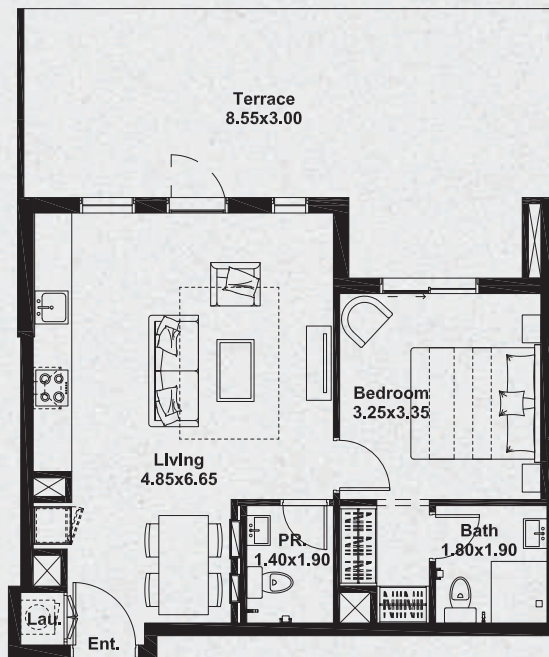

TYPE	LEVEL	UNIT (SQ.FT)	BALCONY (SQ.FT)	TOTAL (SQ.FT)
1BR/C1	1	578	337	915

NOOR 3

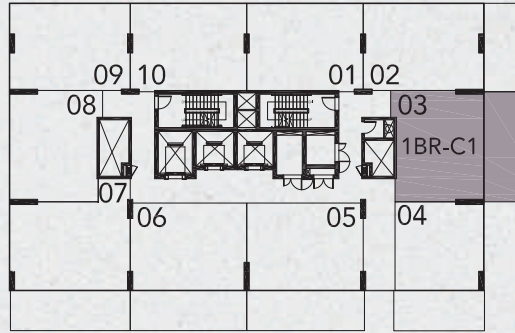

LEVEL 1

NOOR 2 & 4

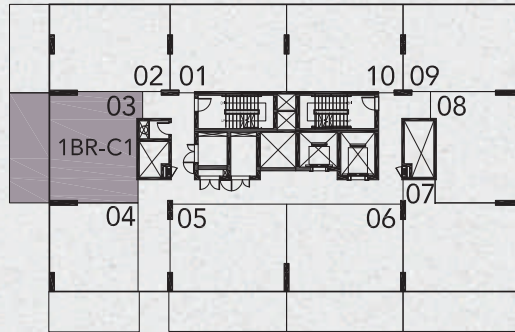

LEVEL 1

NOOR 1

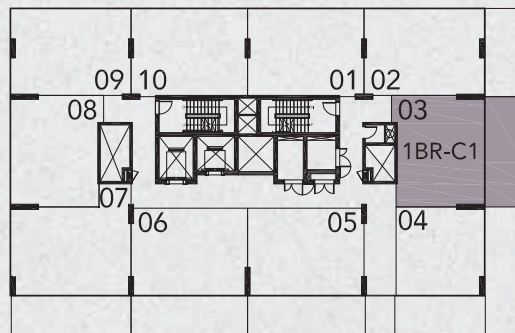

LEVEL 1

1BR - TYPE D

نور 1, 2, 3 & 4
شقة مكونة من غرفة نوم واحدة - نموذج D
NOOR 1, 2, 3 & 4
ONE BEDROOM APARTMENT - TYPE D

1BR/D

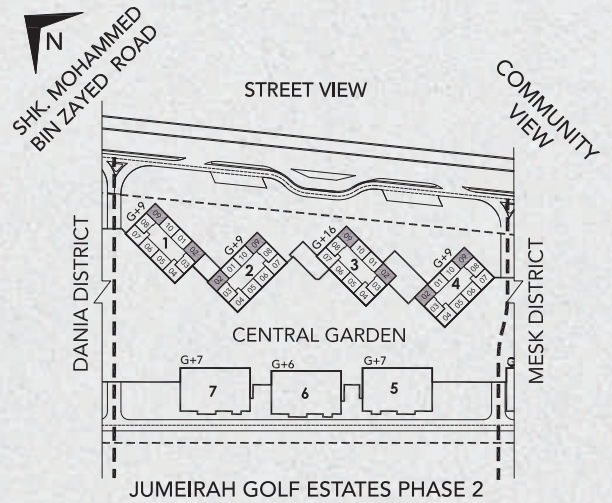
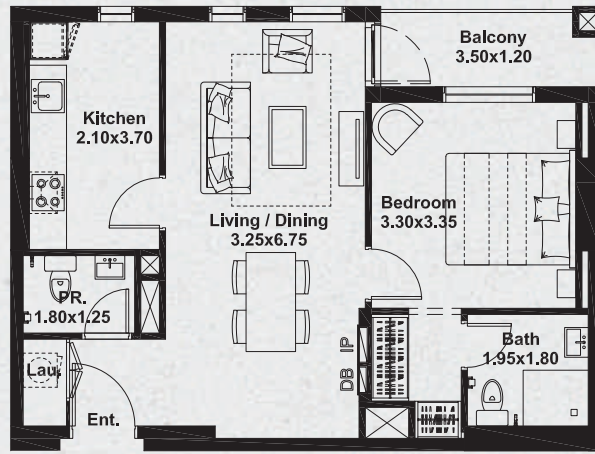

TYPE	LEVEL	UNIT (SQ.FT)	BALCONY (SQ.FT)	TOTAL (SQ.FT)
1BR/D	1-9	628	52	680

إن جميع الصور والمخططات والتصاميم والمعلومات والبيانات والتفاصيل الواردة في هذا الكتيب هي إرشادية فقط وقد تتغير في أي وقت حسب التصاميم النهائية للمشروع والموافقات التنظيمية وتصاريح التخطيط.

All pictures, plans, layouts, information, data and details included in this brochure are indicative only and may change at any time in accordance with the final designs of the project, regulatory approvals and planning permissions.

NOOR 2 & 4

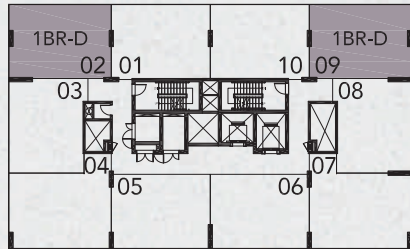

LEVEL 2-9

NOOR 2 & 4

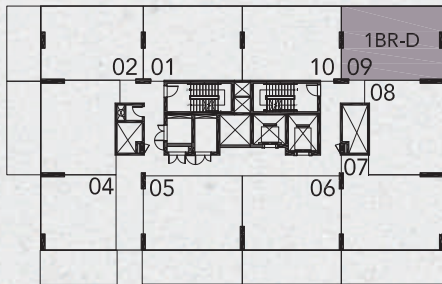

LEVEL 1

NOOR 1

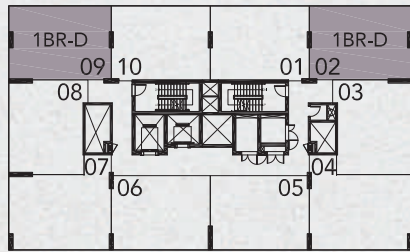

LEVEL 2-9

NOOR 3

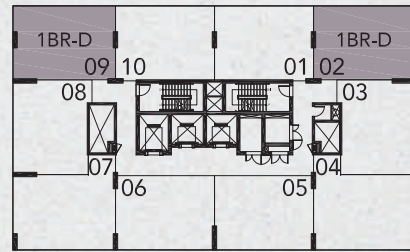

LEVEL 2-8

NOOR 1

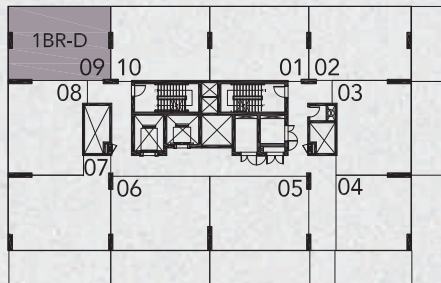

LEVEL 1

NOOR 3

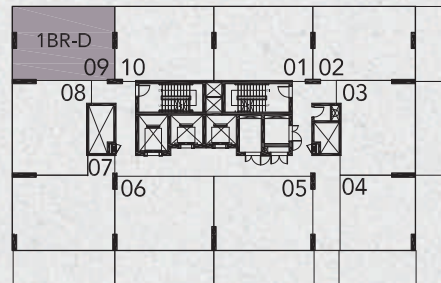

LEVEL 1

1BR - TYPE D1

نور 1, 2, 3 & 4
شقة مكونة من غرفة نوم واحدة - نموذج D1
NOOR 1, 2, 3 & 4
ONE BEDROOM APARTMENT - TYPE D1

1BR/D1

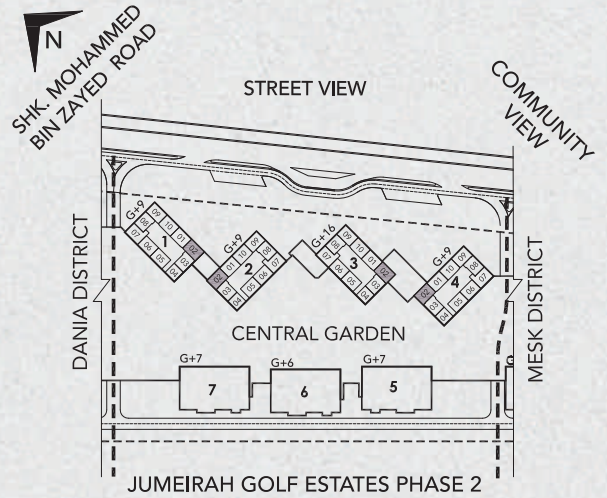
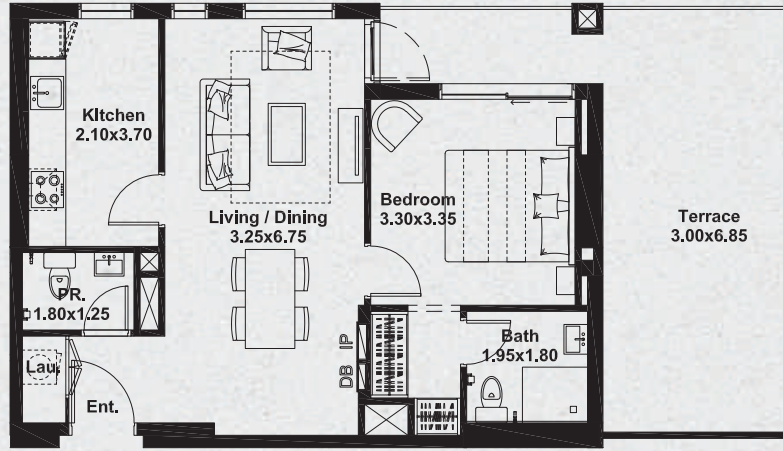

TYPE	LEVEL	UNIT (SQ.FT)	BALCONY (SQ.FT)	TOTAL (SQ.FT)
1BR/D1	1	628	288	916

NOOR 3

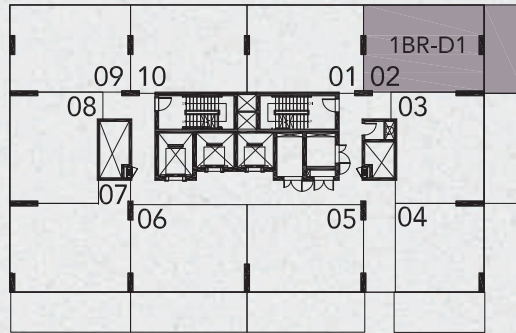

LEVEL 1

NOOR 2 & 4

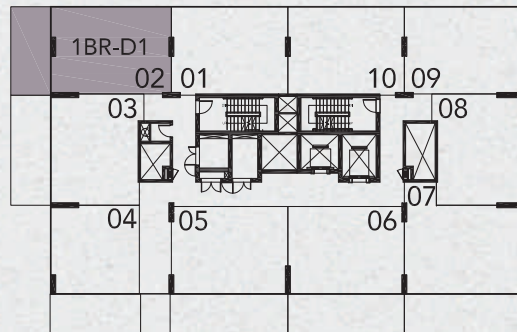

LEVEL 1

NOOR 1

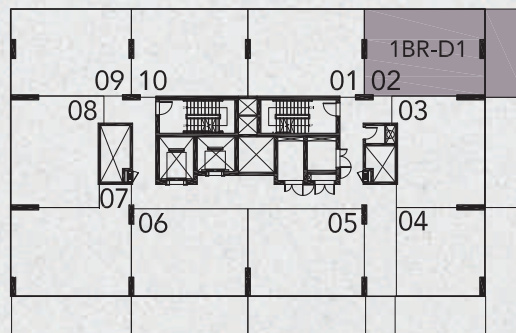

LEVEL 1

نور 1, 2, 3 & 4
شقة مكونة من غرفة نوم واحدة - نموذج E
NOOR 1, 2, 3 & 4
ONE BEDROOM APARTMENT - TYPE E

1BR/E

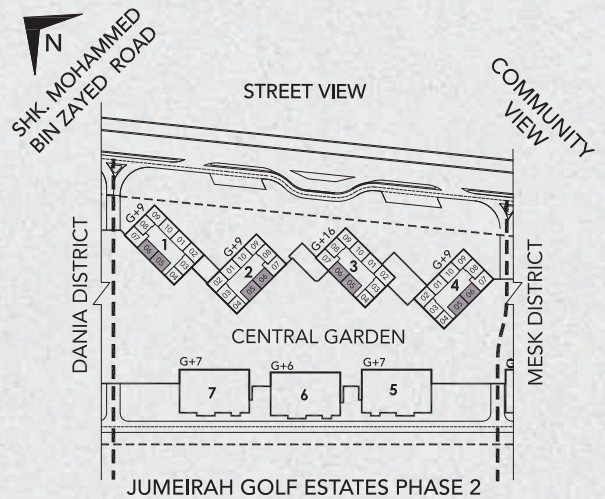
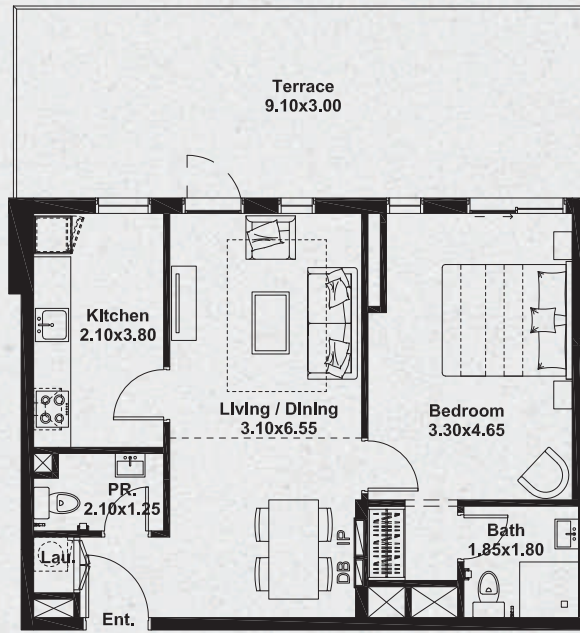

TYPE	LEVEL	UNIT (SQ.FT)	BALCONY (SQ.FT)	TOTAL (SQ.FT)
1BR/E	1	636	313	949
	1	636	317	953

NOOR 3

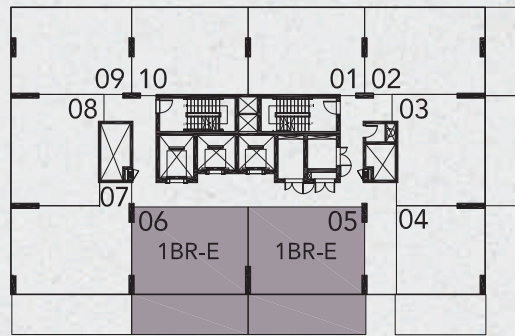

LEVEL 1

NOOR 2 & 4

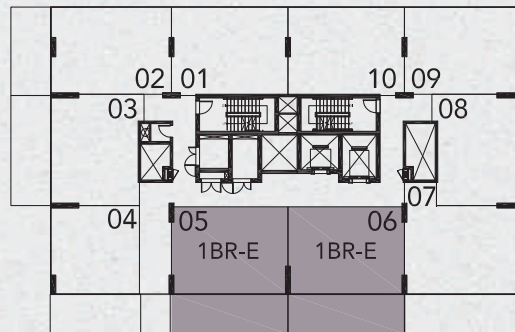

LEVEL 1

NOOR 1

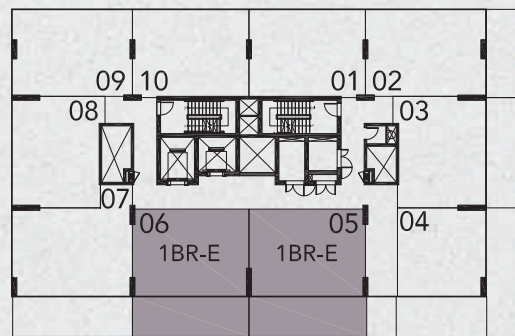

LEVEL 1

شقة مكونة من غرفة نوم واحدة - نموذج F
NOOR 1, 2, 3 & 4
ONE BEDROOM APARTMENT - TYPE F

1BR/F

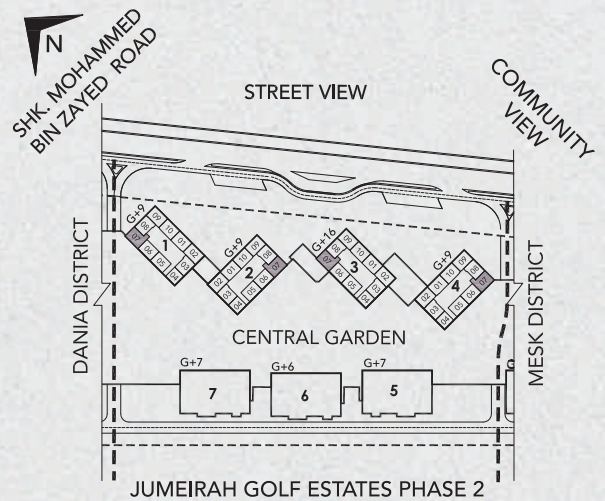
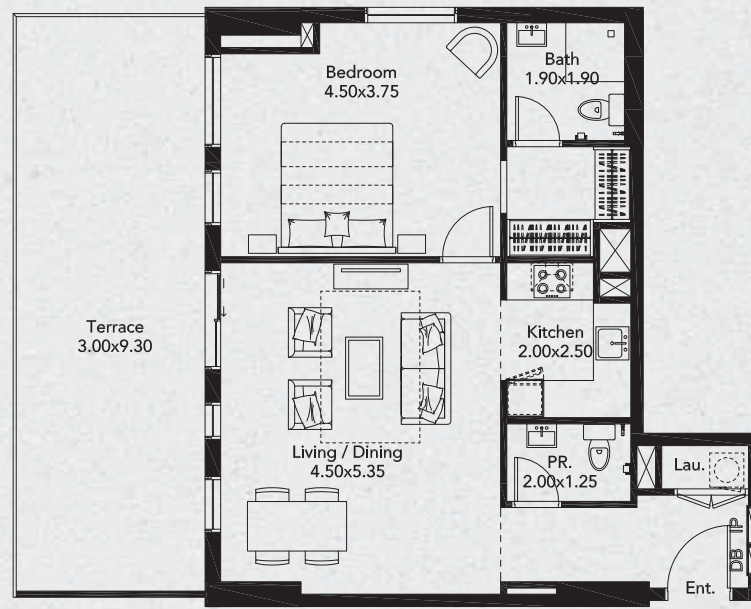

TYPE	LEVEL	UNIT (SQ.FT)	BALCONY (SQ.FT)	TOTAL (SQ.FT)
1BR/F	1	726	322	1,048

NOOR 3

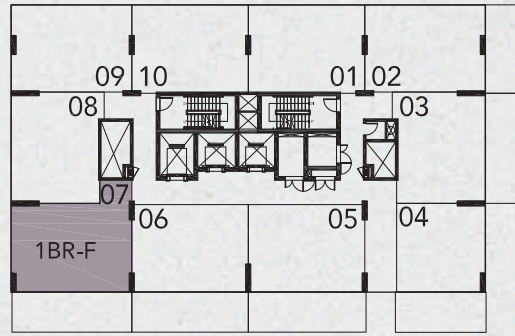

LEVEL 1

NOOR 2 & 4

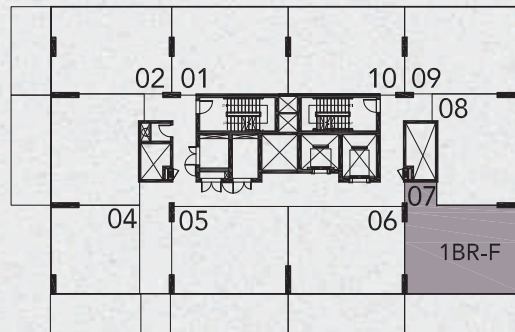

LEVEL 1

NOOR 1

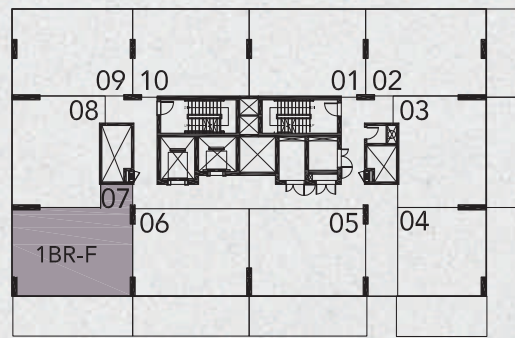

LEVEL 1

1BR - TYPE G

نور 5, 6 & 7
شقة مكونة من غرفة نوم واحدة - نموذج G
NOOR 5, 6 & 7
ONE BEDROOM APARTMENT - TYPE G

1BR/G

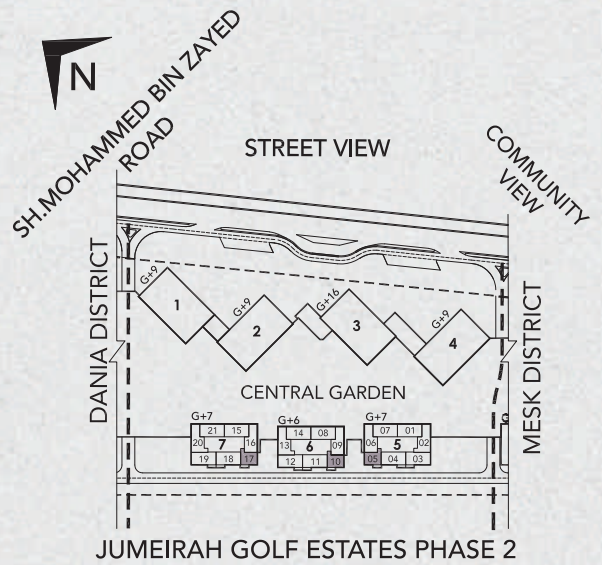
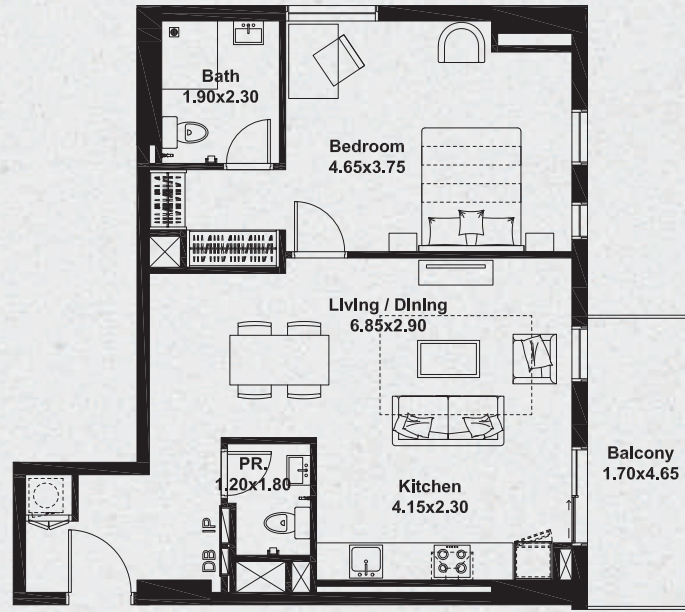

TYPE	LEVEL	UNIT (SQ.FT)	BALCONY (SQ.FT)	TOTAL (SQ.FT)
1BR/G	2-4	737	95	832

LEVEL 2-4

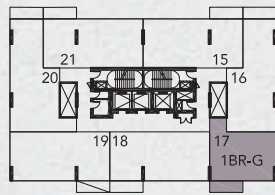

NOOR 7

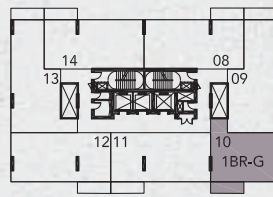

NOOR 6

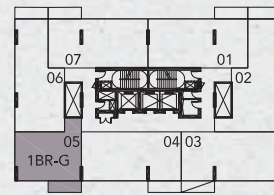

NOOR 5

1BR - TYPE H

نور 5, 6 & 7
شقة مكونة من غرفة نوم واحدة - نموذج H
NOOR 5, 6 & 7
ONE BEDROOM APARTMENT - TYPE H

1BR/H

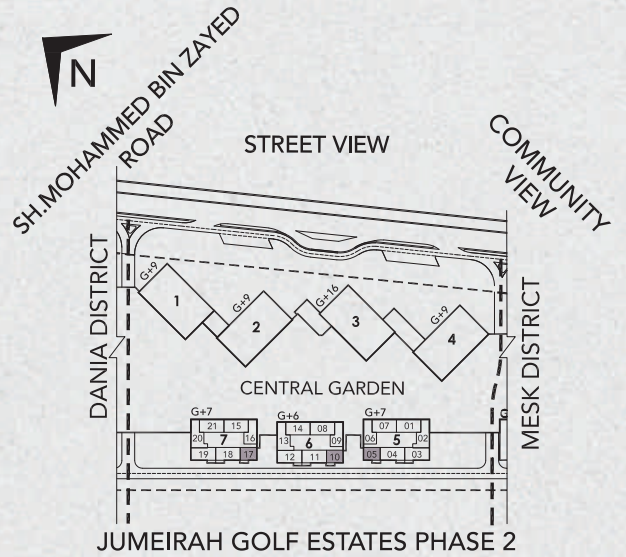
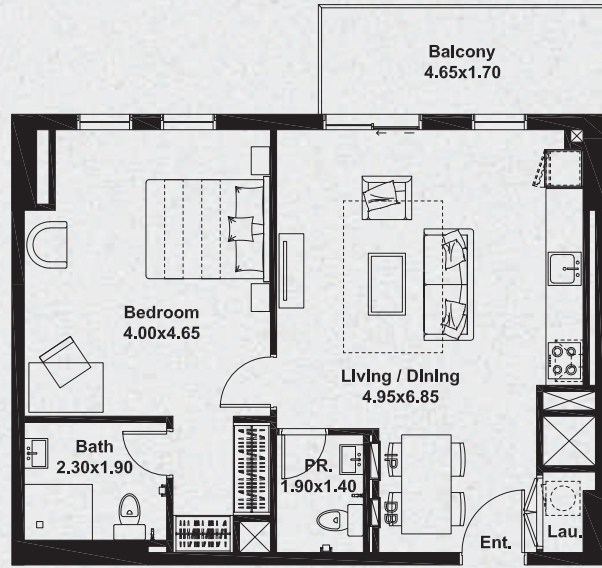

TYPE	LEVEL	UNIT (SQ.FT)	BALCONY (SQ.FT)	TOTAL (SQ.FT)
1BR/H	M	694	95	789
	1			
	5-6			
	7			

LEVEL 7

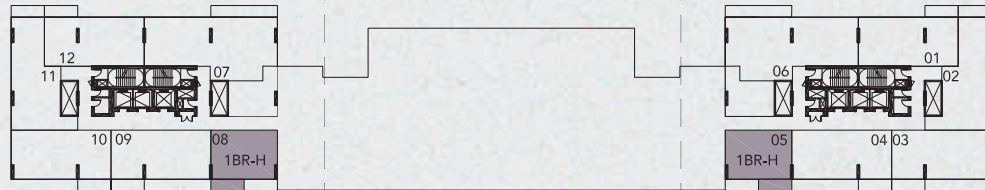

LEVEL 5-6

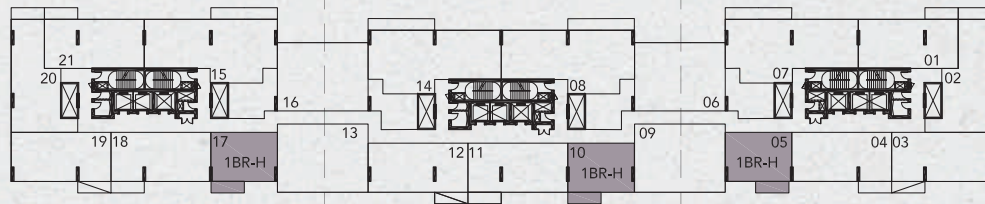

LEVEL 1

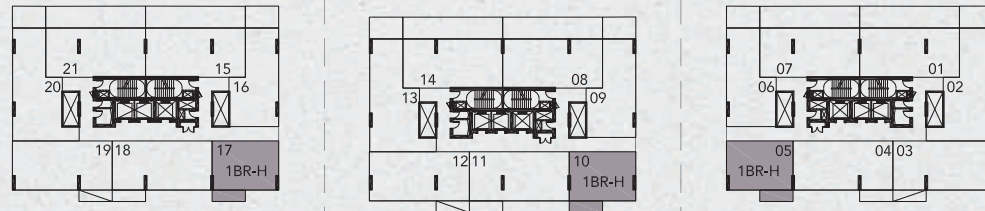

LEVEL M

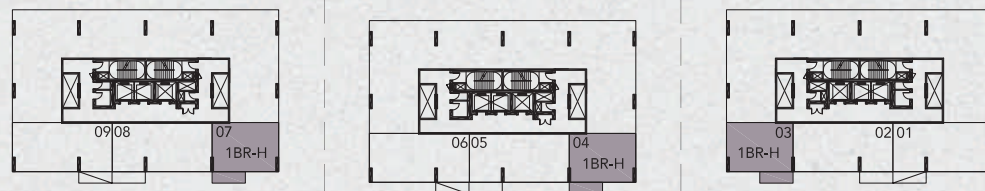

NOOR 7

NOOR 6

NOOR 5

شقة مكونة من غرفة نوم واحدة - نموذج I
NOOR 5, 6 & 7
ONE BEDROOM APARTMENT - TYPE I

1BR/I

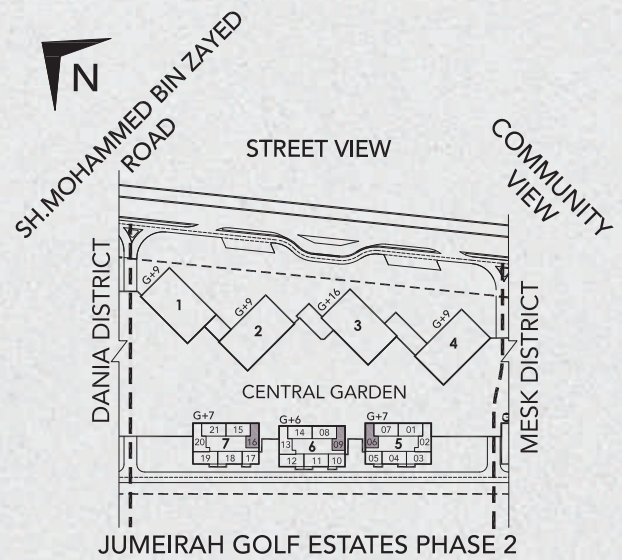
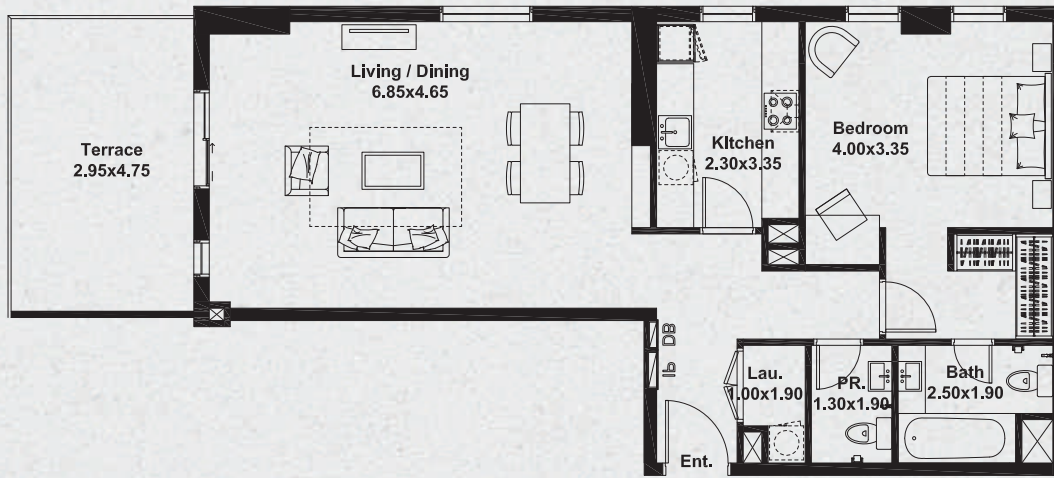

TYPE	LEVEL	UNIT (SQ.FT)	BALCONY (SQ.FT)	TOTAL (SQ.FT)
1BR/I	1	886	160	1,047

LEVEL 1

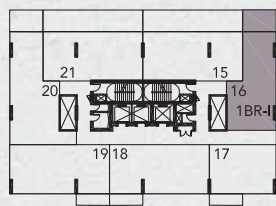

NOOR 7

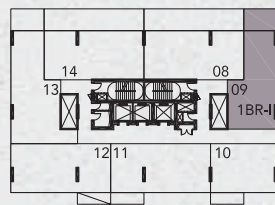

NOOR 6

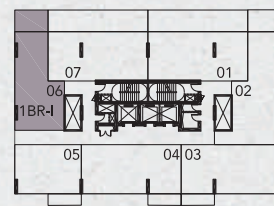

NOOR 5

نور 3
شقة مكونة من غرفتي نوم - نموذج A
NOOR 3
TWO BEDROOM APARTMENT - TYPE A

2BR/A

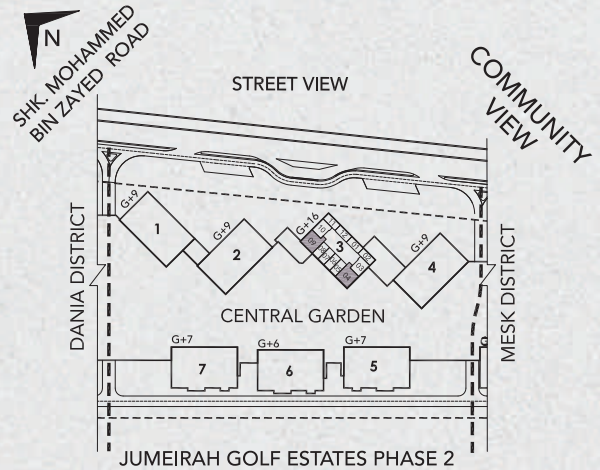
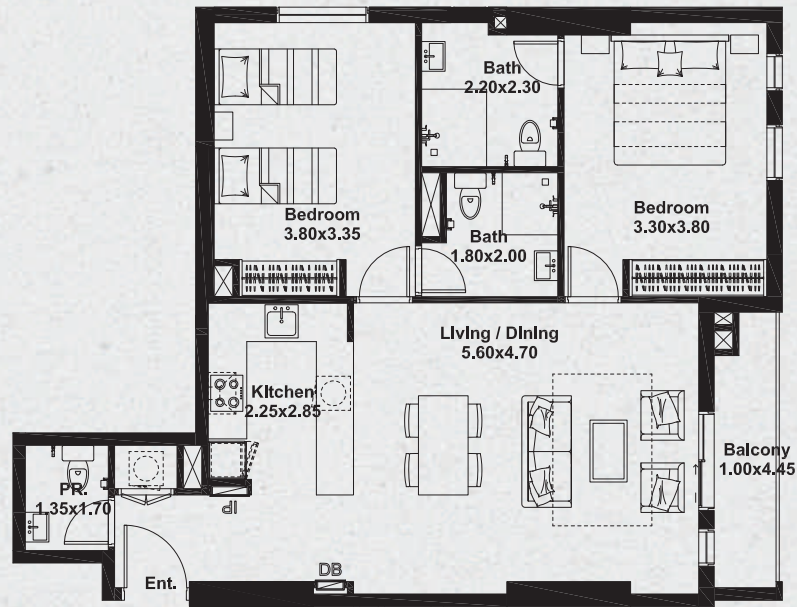

TYPE	LEVEL	UNIT (SQ.FT)	BALCONY (SQ.FT)	TOTAL (SQ.FT)
2BR/A	09-16	939	54	993

NOOR 3

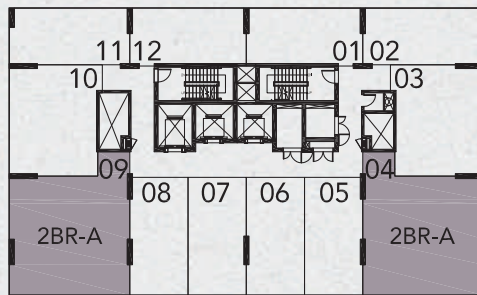

LEVEL 10-16

NOOR 3

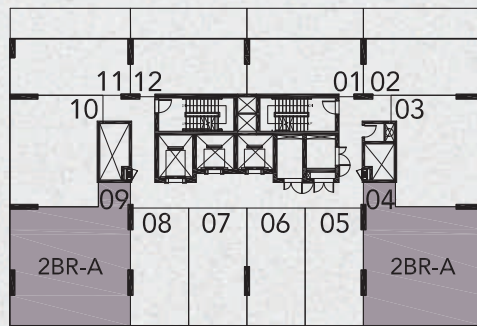

LEVEL 9

2BR - TYPE B

نور 5, 6, 7
شقة مكونة من غرفتي نوم - نموذج B
NOOR 5, 6 & 7
TWO BEDROOM APARTMENT - TYPE B

2BR/B

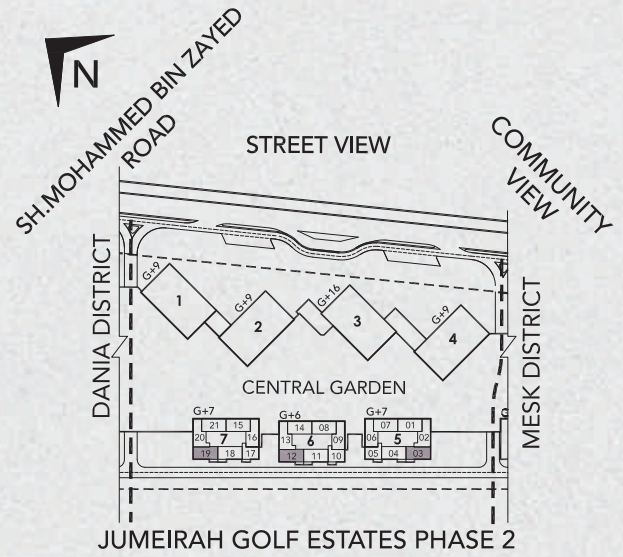
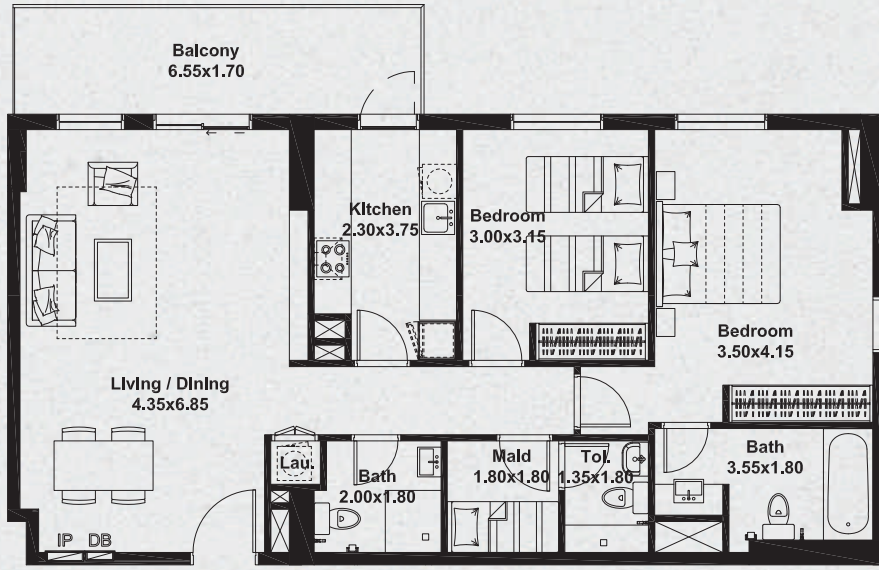

TYPE	LEVEL	UNIT (SQ.FT)	BALCONY (SQ.FT)	TOTAL (SQ.FT)
2BR/B	M	1,033	133	1,166
	1-4			
	5-6			
	7			

LEVEL 7

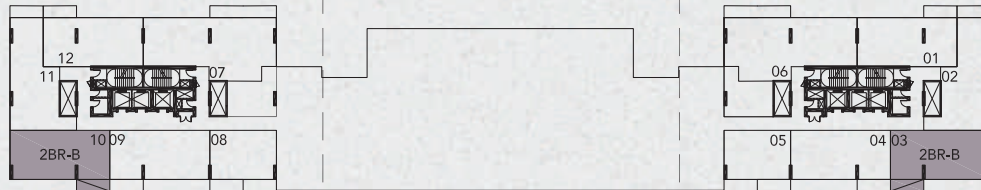

LEVEL 5-6

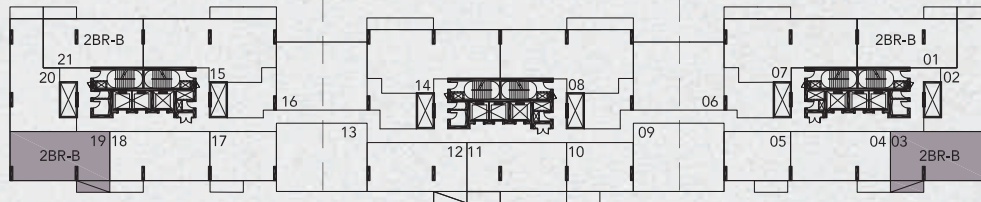

LEVEL 2-4

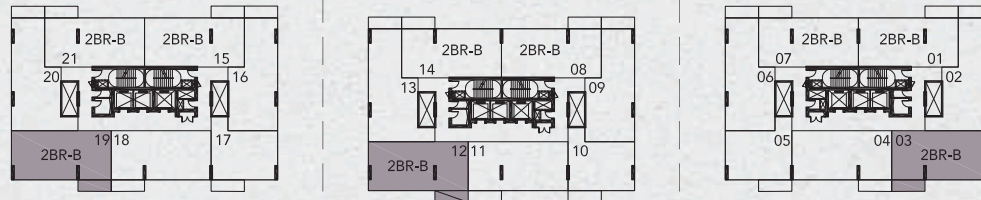

LEVEL 1

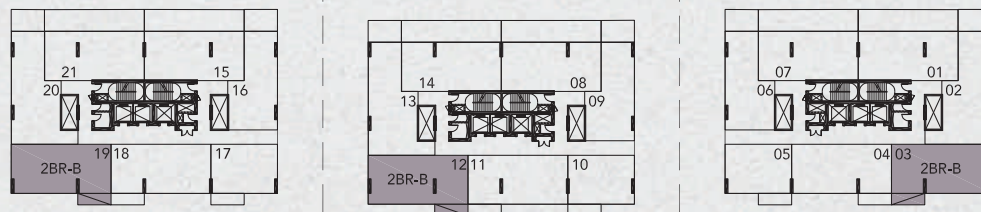

LEVEL M

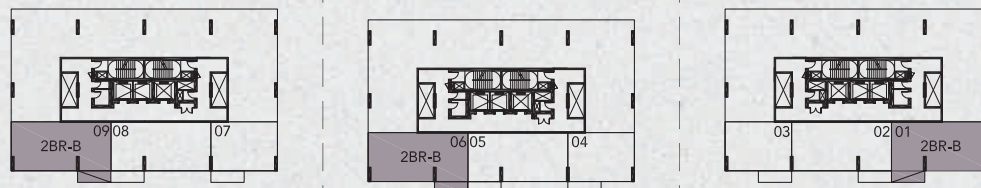

NOOR 7

NOOR 6

NOOR 5

2BR - TYPE B*

نور 5, 6 & 7

شقة مكونة من غرفتي نوم - نموذج *B

NOOR 5, 6 & 7

TWO BEDROOM APARTMENT - TYPE B*

2BR/B*

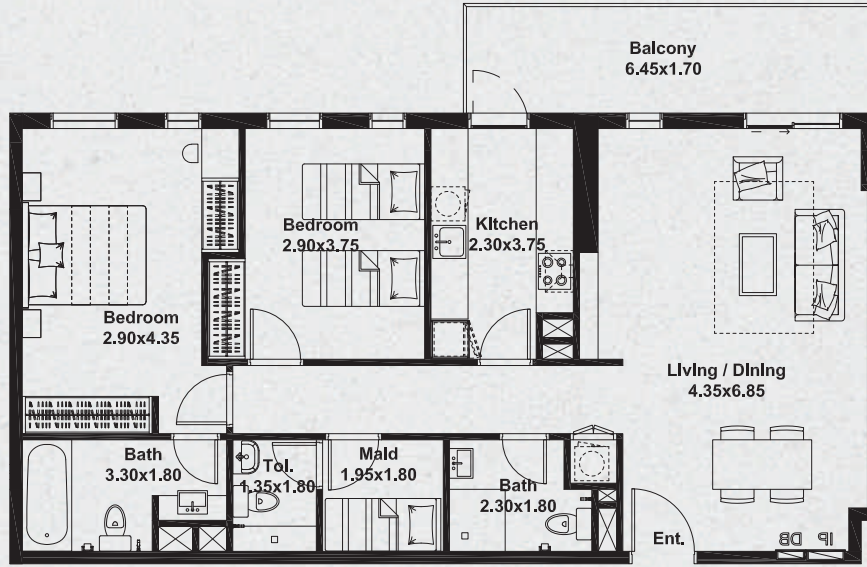

TYPE	LEVEL	UNIT (SQ.FT)	BALCONY (SQ.FT)	TOTAL (SQ.FT)
2BR/B*	M	1,032	133	1,165
	1-4			
	5-6			
	7	1,054	130	1,184
	2-4			
	5-6			
7				

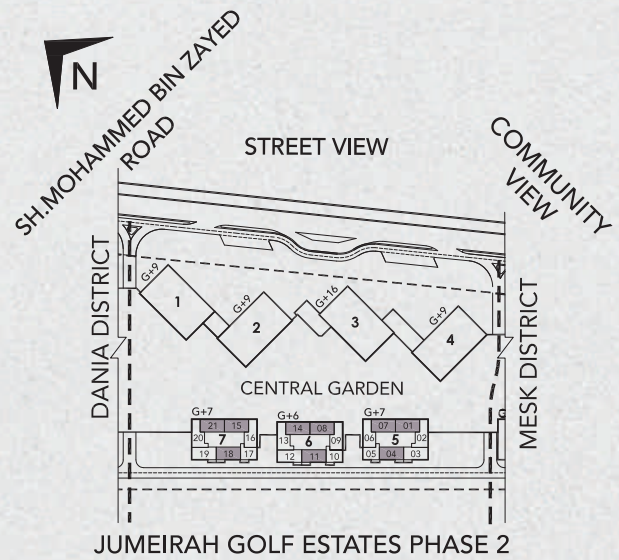

إن جميع الصور والمخططات والتصاميم والمعلومات والبيانات والتفاصيل الواردة في هذا الكتيب هي إرشادية فقط وقد تتغير في أي وقت حسب التصاميم النهائية للمشروع والموافقات التنظيمية وتصاريح التخطيط.

All pictures, plans, layouts, information, data and details included in this brochure are indicative only and may change at any time in accordance with the final designs of the project, regulatory approvals and planning permissions.

LEVEL 7

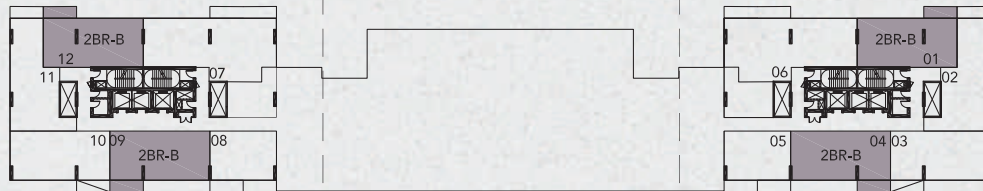

LEVEL 5-6

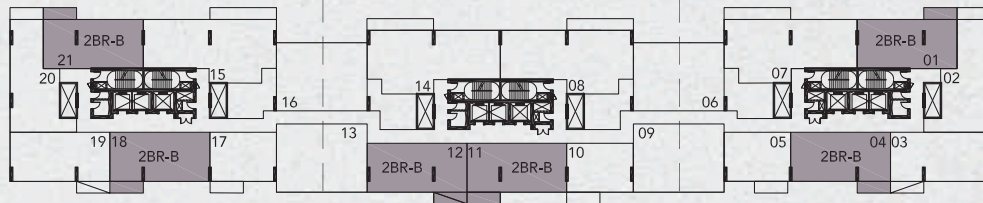

LEVEL 2-4

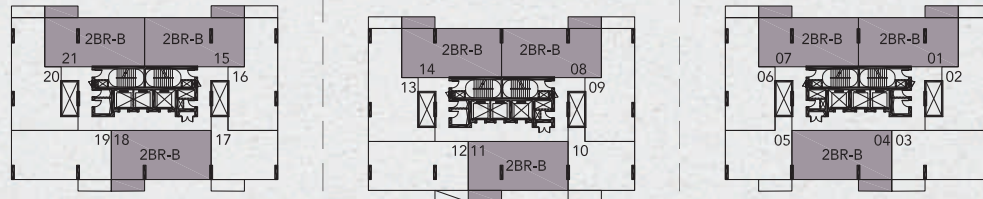

LEVEL 1

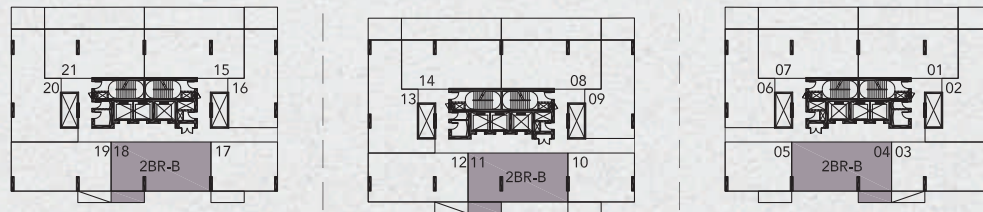

LEVEL M

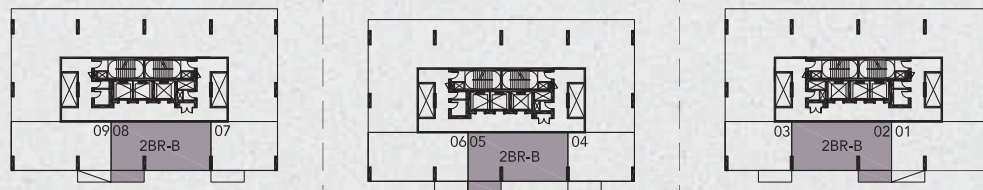

NOOR 7

NOOR 6

NOOR 5

نور 5, 6 & 7
شقة مكونة من غرفتي نوم - نموذج C

NOOR 5, 6 & 7
TWO BEDROOM APARTMENT - TYPE C

2BR/C

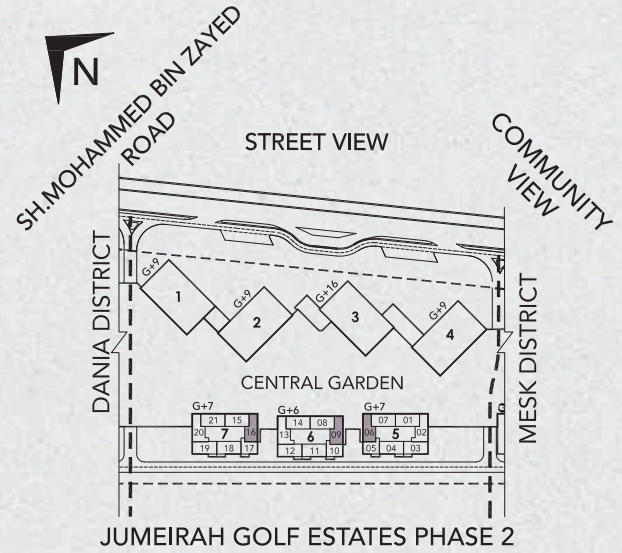
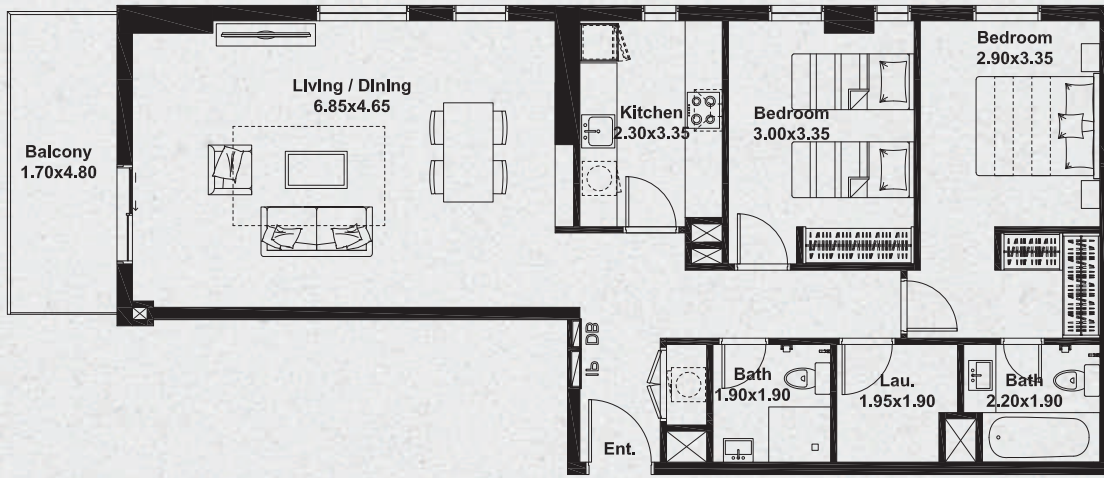

TYPE	LEVEL	UNIT (SQ.FT)	BALCONY (SQ.FT)	TOTAL (SQ.FT)
2BR/C	2-4	1,043	98	1,141

LEVEL 2-4

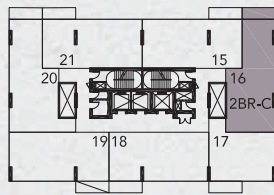

NOOR 7

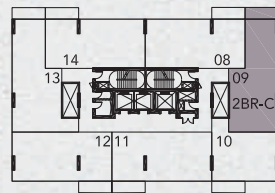

NOOR 6

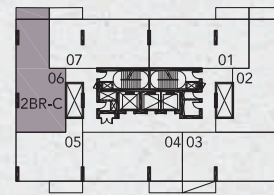

NOOR 5

نور 5, 6 & 7
شقة مكونة من غرفتي نوم - نموذج D
NOOR 5, 6 & 7
TWO BEDROOM APARTMENT - TYPE D

2BR/D

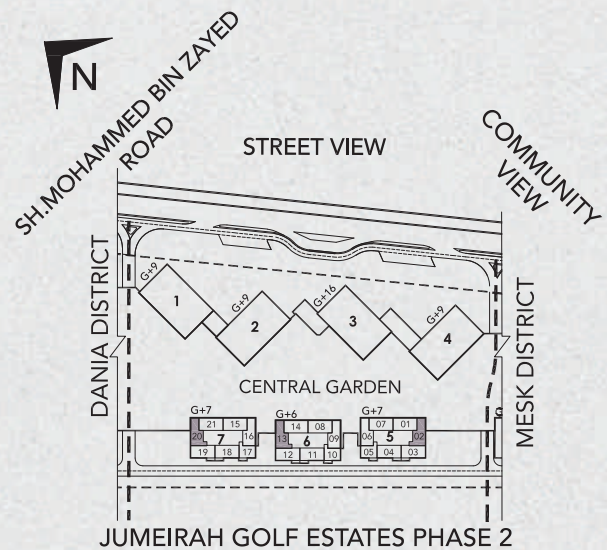
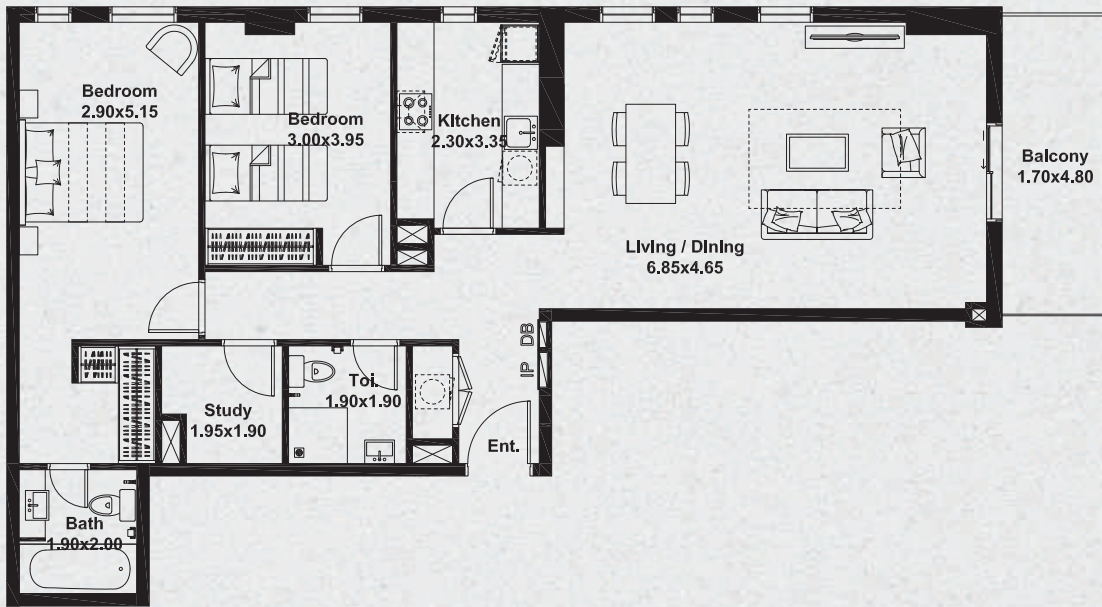

TYPE	LEVEL	UNIT (SQ.FT)	BALCONY (SQ.FT)	TOTAL (SQ.FT)
2BR/D	2-4	1,094	98	1,192
	5-6			
	7			

LEVEL 7

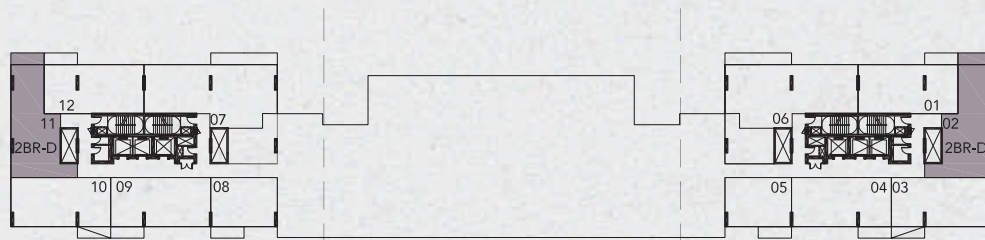

LEVEL 5-6

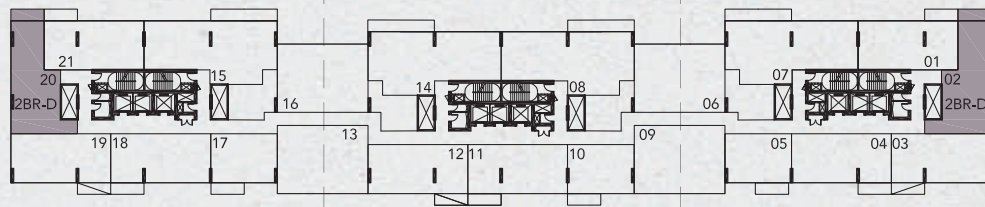

LEVEL 2-4

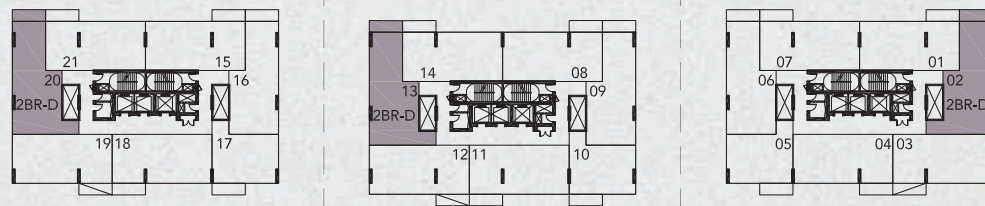

NOOR 7

NOOR 6

NOOR 5

2BR - TYPE E

نور 5, 6 & 7
شقة مكونة من غرفتي نوم - نموذج E
NOOR 5, 6 & 7
TWO BEDROOM APARTMENT - TYPE E

2BR/E

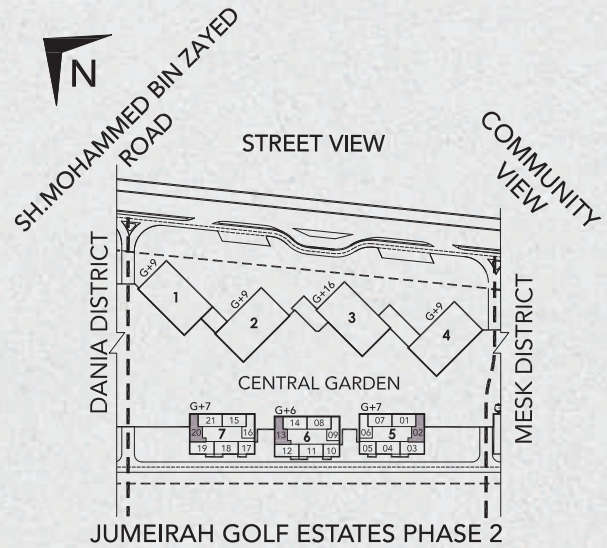
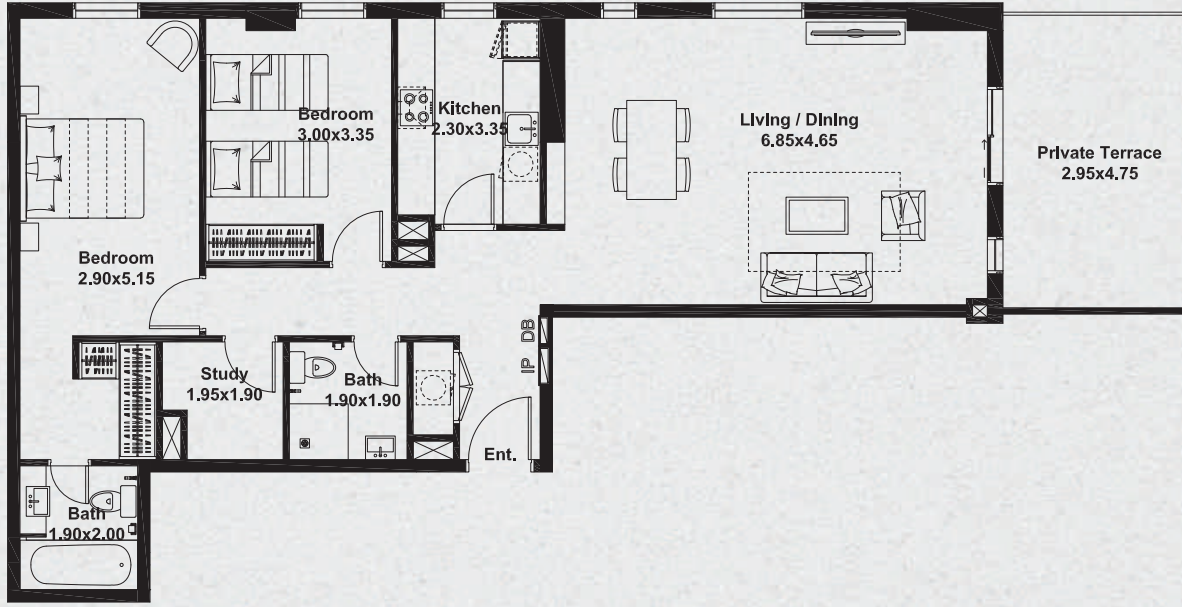

TYPE	LEVEL	UNIT (SQ.FT)	BALCONY (SQ.FT)	TOTAL (SQ.FT)
2BR/E	1	1,094	160	1,254

LEVEL 1

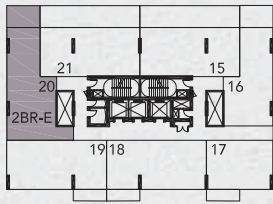

NOOR 7

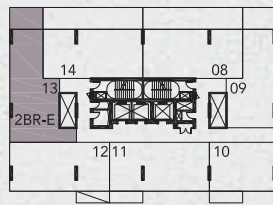

NOOR 6

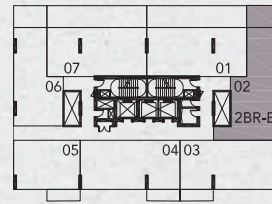

NOOR 5

2BR - TYPE F

نور 5, 6 & 7
شقة مكونة من غرفتي نوم - نموذج F

NOOR 5, 6 & 7
TWO BEDROOM APARTMENT - TYPE F

2BR/F

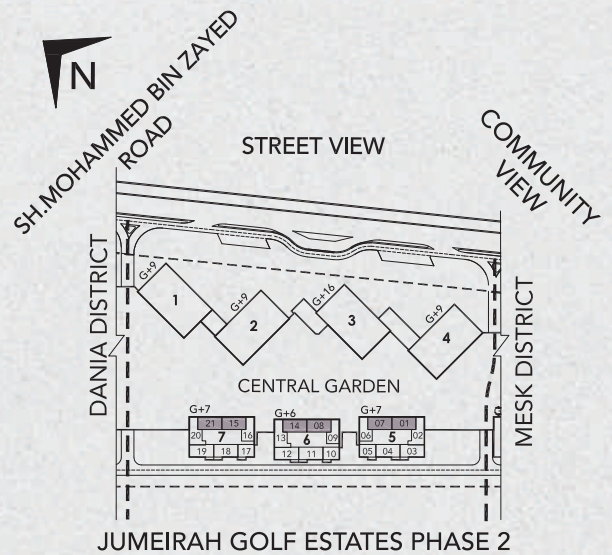
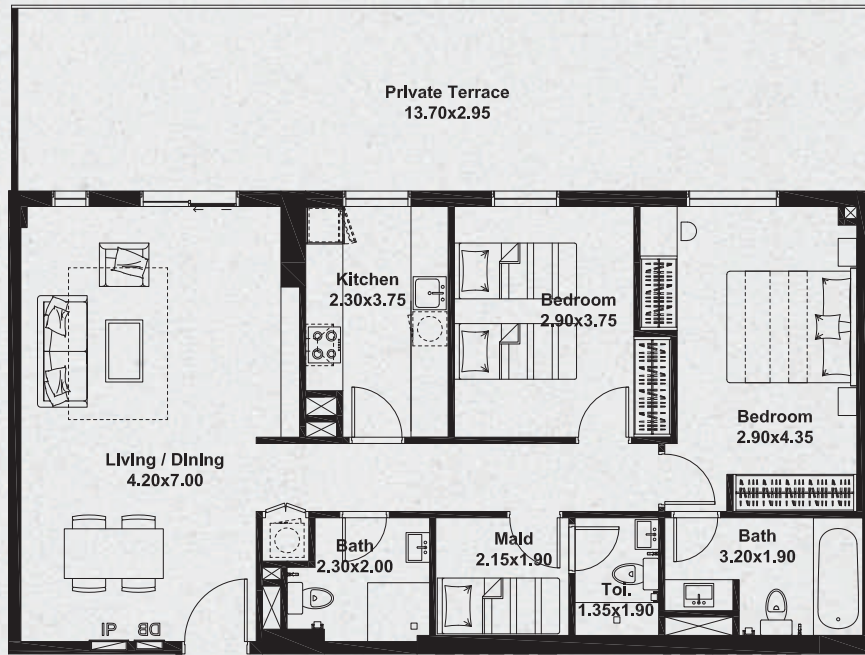

TYPE	LEVEL	UNIT (SQ.FT)	BALCONY (SQ.FT)	TOTAL (SQ.FT)
2BR/F	1	1,055	460	1,515

LEVEL 1

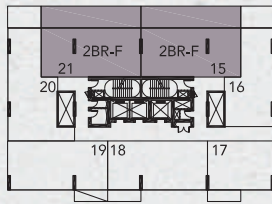

NOOR 7

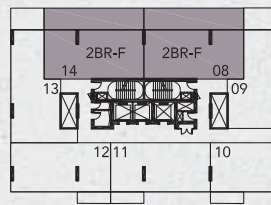

NOOR 6

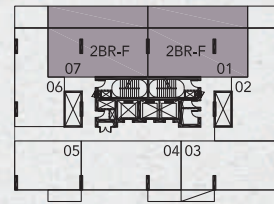

NOOR 5

نور 5, 6 & 7
شقة مكونة من غرفتي نوم - نموذج G
NOOR 5, 6 & 7
TWO BEDROOM APARTMENT - TYPE G

2BR/G

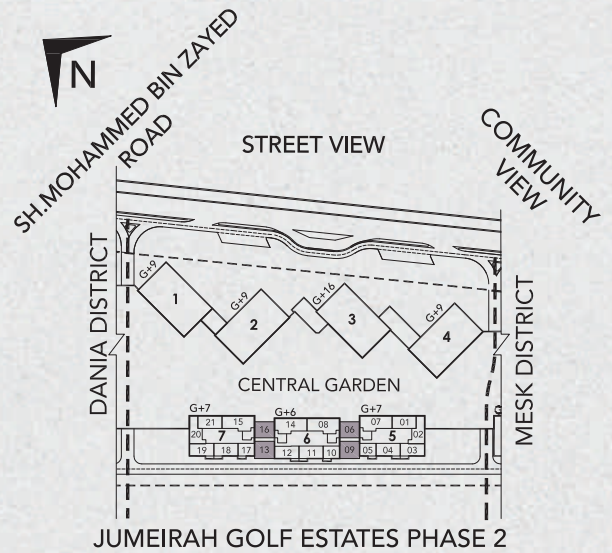
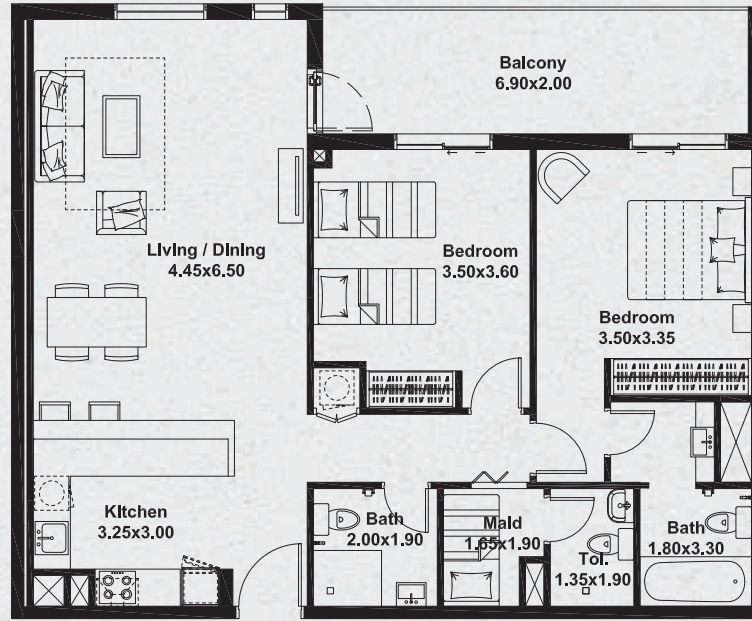

TYPE	LEVEL	UNIT (SQ. FT)	BALCONY (SQ. FT)	TOTAL (SQ. FT)
2BR/G	5-6	1,063	165	1,228
	5-6	1,105	133	1,238

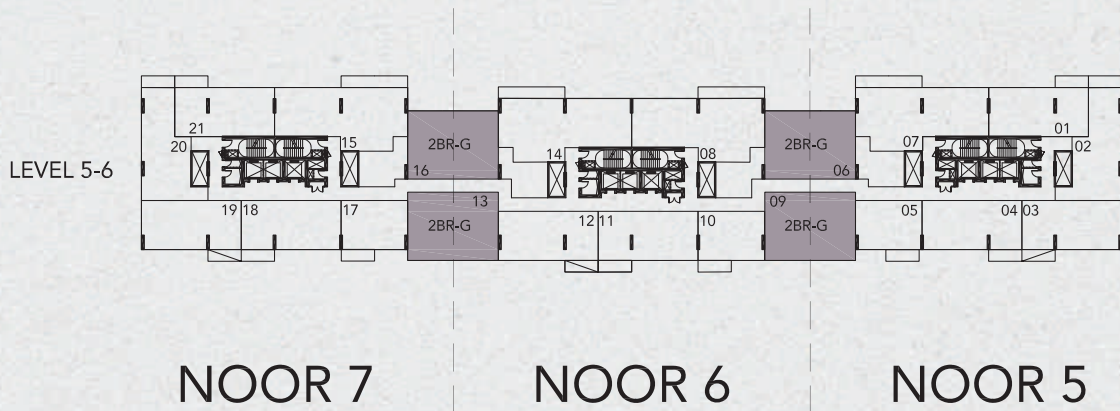

نور 5, 6 & 7
شقة مكونة من ثلاث غرف نوم - نموذج A
NOOR 5, 6 & 7
THREE BEDROOM APARTMENT - TYPE A

3BR/A

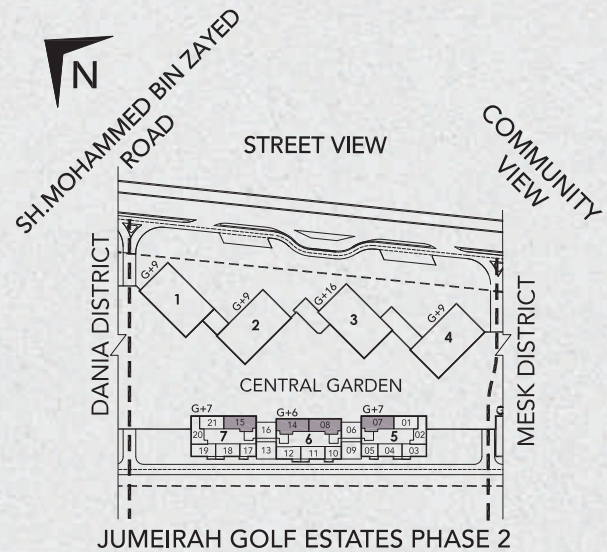
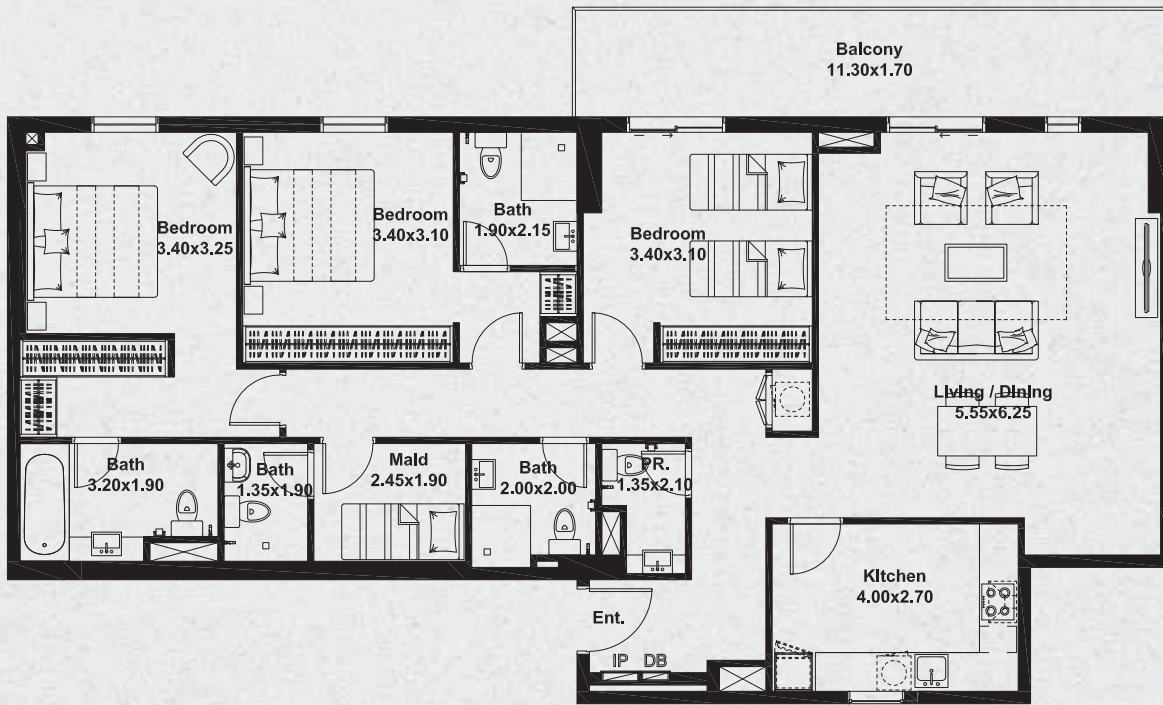

TYPE	LEVEL	UNIT (SQ. FT)	BALCONY (SQ. FT)	TOTAL (SQ. FT)
3BR/A	5-7	1,572	232	1,804

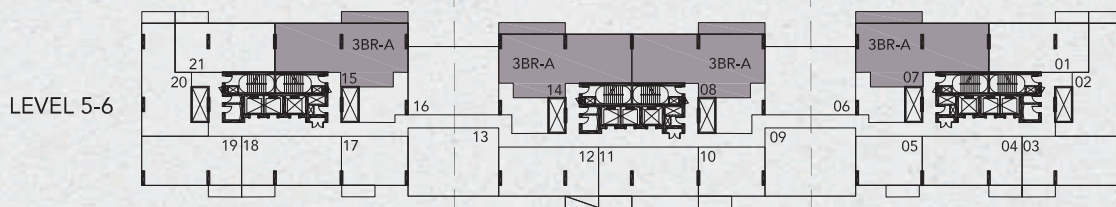
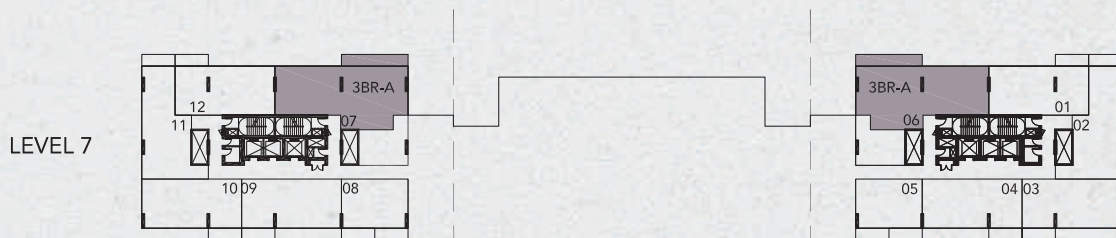

NOOR 7

NOOR 6

NOOR 5